

Binaro 29

0	0				
0			0		
	0				
		1			
			0		
	0	1			

Binaro 29 *

			0		
0			0		
0	1				
1	1			1	

Binaro 30

0					0
		1			
		0		0	1
	1	1			1
				0	0

Binaro 30 *

1		0			1
0		0	0		
0	0				

Binaro 31

	0		0		0
1					
			0	0	
		1	1		0

Binaro 31 *

		1			0
1			0		
	1				
1		1			
				0	
			0		

Binaro 32

					1
	0				
		1	1		
			1		0
0					0

Binaro 32 *

			0		
1	1			1	
	1				
				0	
					1
0		1			

Participant

Classe 2024-2025

Participant

Classe 2024-2025

Clôtures 29

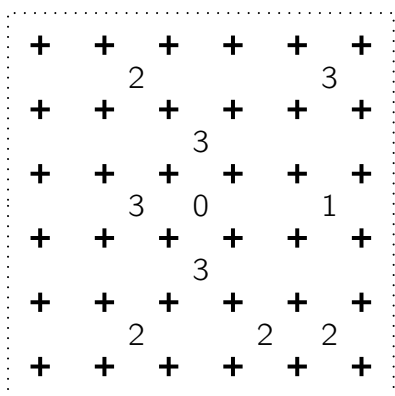

Clôtures 29 *

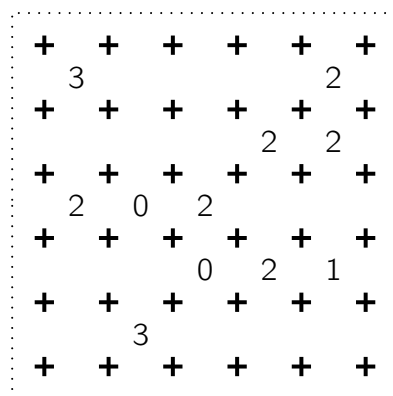

Clôtures 30

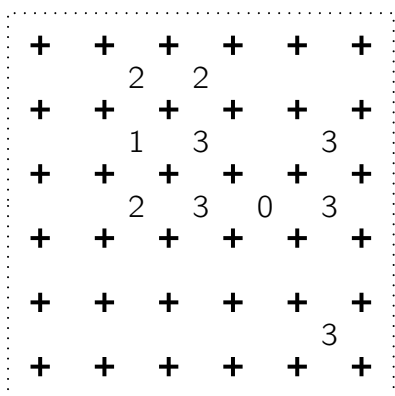

Clôtures 30 *

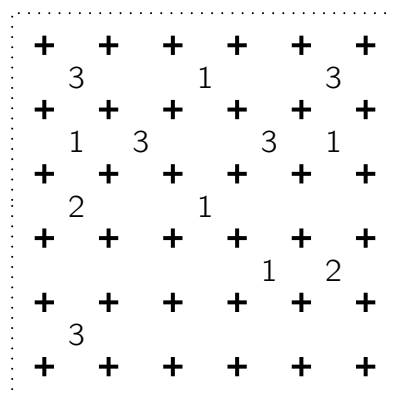

Clôtures 31

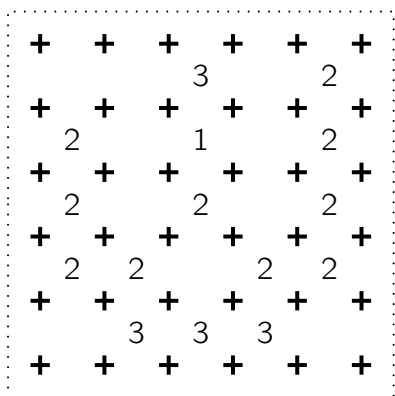

Clôtures 31 *

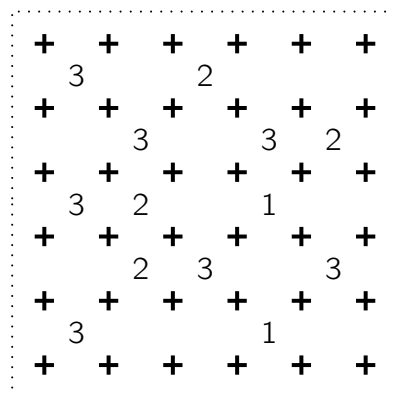

Clôtures 32

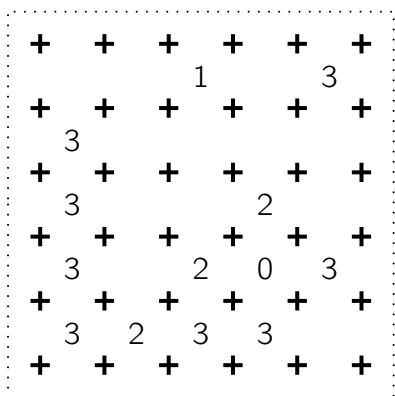

Clôtures 32 *

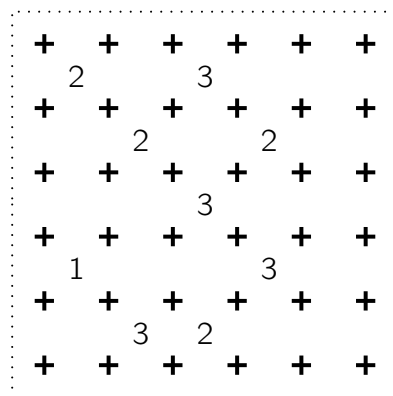

Participant

Classe 2024-2025

Participant

Classe 2024-2025

Dominos 29

0	3	0	3	1
2	2	1	2	0
0	2	1	2	3
0	1	3	3	1

0·0	0·1	0·2	0·3	1·1
1·2	1·3	2·2	2·3	3·3

Dominos 29 *

0	3	1	3	3
0	1	1	2	2
2	0	0	1	0
2	3	2	3	1

0·0	0·1	0·2	0·3	1·1
1·2	1·3	2·2	2·3	3·3

Dominos 30

3	1	2	1	0
0	0	3	0	2
3	2	2	3	1
1	0	2	3	1

0·0	0·1	0·2	0·3	1·1
1·2	1·3	2·2	2·3	3·3

Dominos 30 *

3	0	0	2	0
2	2	0	3	1
1	1	1	3	0
3	3	1	2	2

0·0	0·1	0·2	0·3	1·1
1·2	1·3	2·2	2·3	3·3

Dominos 31

1	2	3	0	2
0	2	3	0	3
1	1	1	2	2
1	0	0	3	3

0·0	0·1	0·2	0·3	1·1
1·2	1·3	2·2	2·3	3·3

Dominos 31 *

0	2	3	3	0
1	3	1	1	0
1	2	0	1	3
2	2	0	2	3

0·0	0·1	0·2	0·3	1·1
1·2	1·3	2·2	2·3	3·3

Dominos 32

2	1	3	2	2
3	0	0	2	1
1	3	3	0	1
0	1	2	3	0

0·0	0·1	0·2	0·3	1·1
1·2	1·3	2·2	2·3	3·3

Dominos 32 *

3	2	2	3	0
1	1	1	1	3
2	3	3	0	2
1	0	0	0	2

0·0	0·1	0·2	0·3	1·1
1·2	1·3	2·2	2·3	3·3

Participant

Classe 2024-2025

Participant

Classe 2024-2025

Gratte-ciel 29

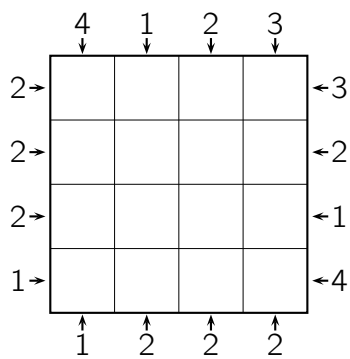

Gratte-ciel 29 *

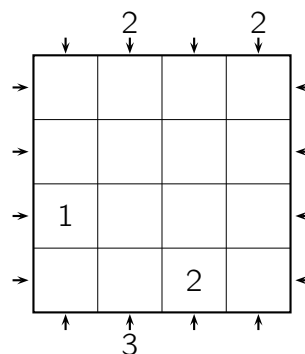

Gratte-ciel 30

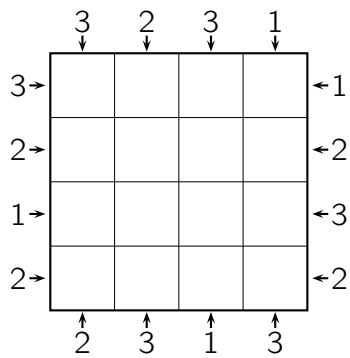

Gratte-ciel 30 *

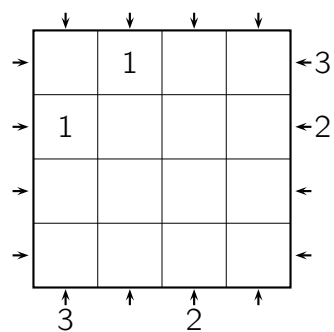

Gratte-ciel 31

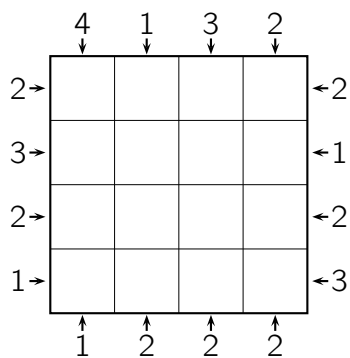

Gratte-ciel 31 *

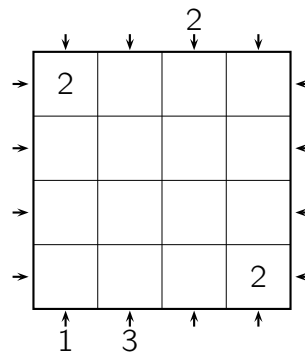

Gratte-ciel 32

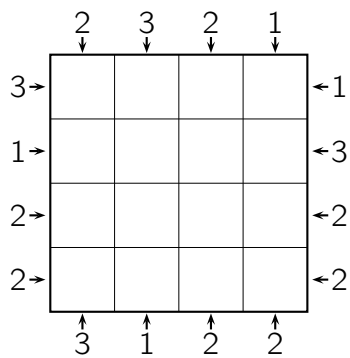

Gratte-ciel 32 *

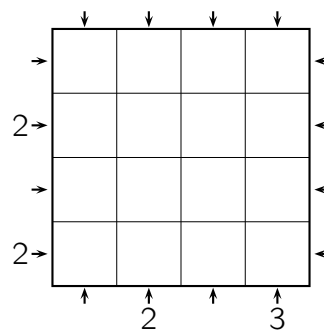

Participant

Classe 2024-2025

Participant

Classe 2024-2025

Slants 29

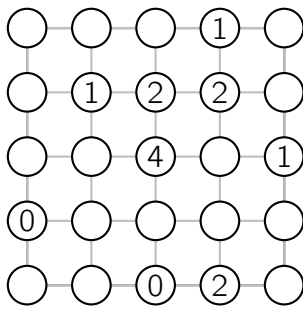

Slants 29 *

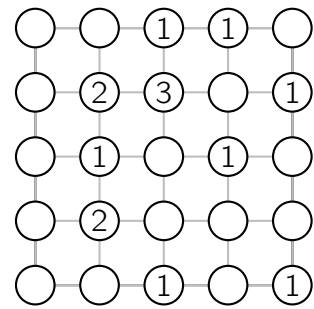

Slants 30

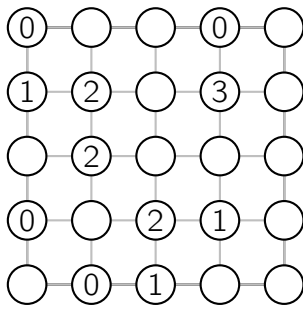

Slants 30 *

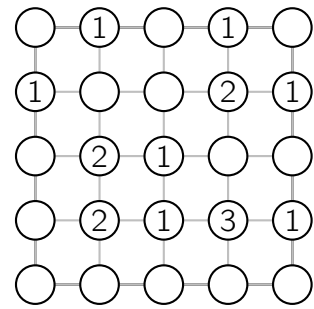

Slants 31

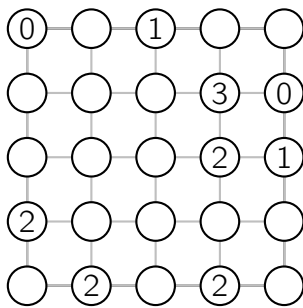

Slants 31 *

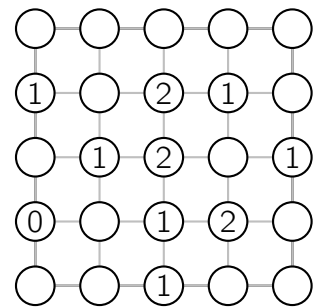

Slants 32

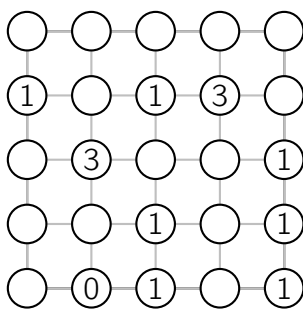

Slants 32 *

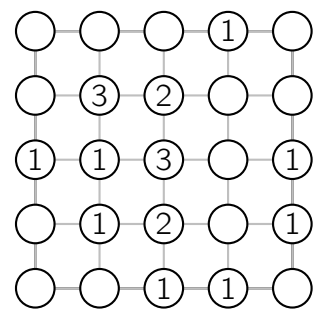

Participant

Classe 2024-2025

Participant

Classe 2024-2025

Squaro 29

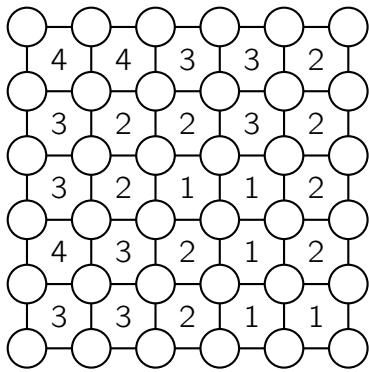

Squaro 29 *

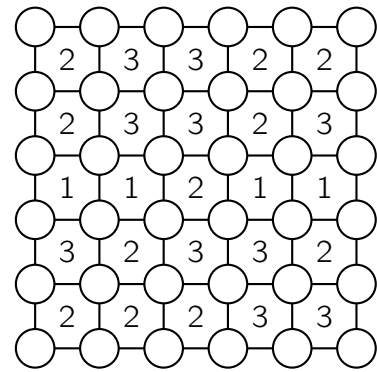

Squaro 30

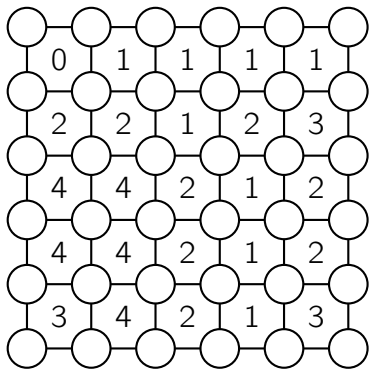

Squaro 30 *

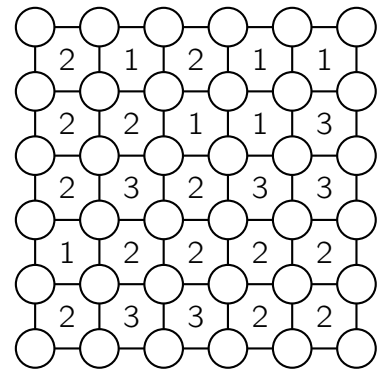

Squaro 31

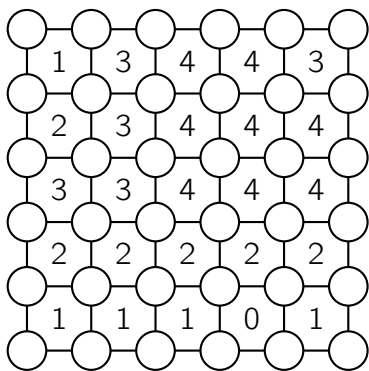

Squaro 31 *

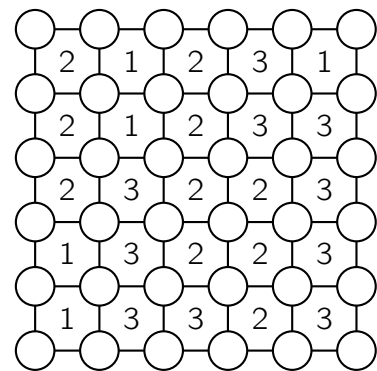

Squaro 32

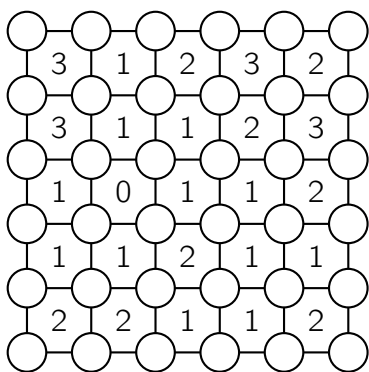

Squaro 32 *

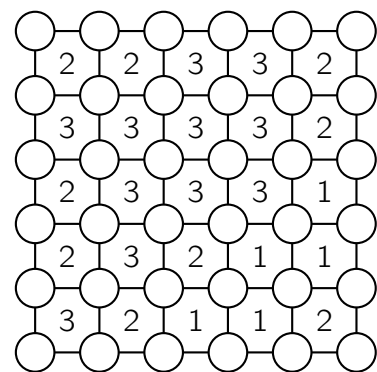

Participant

Classe 2024-2025

Participant

Classe 2024-2025

Tentes 29

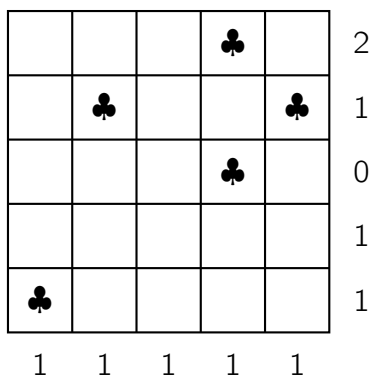

Tentes 29 *

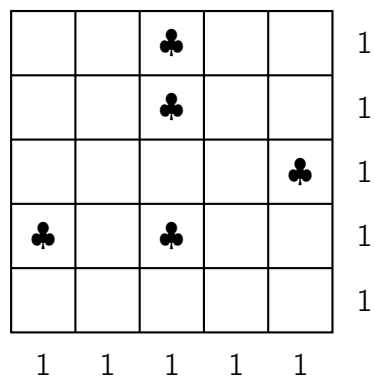

Tentes 30

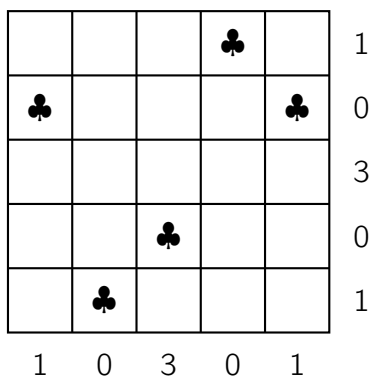

Tentes 30 *

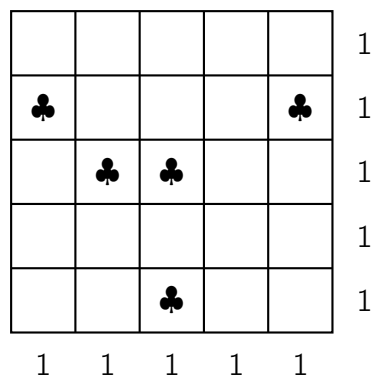

Tentes 31

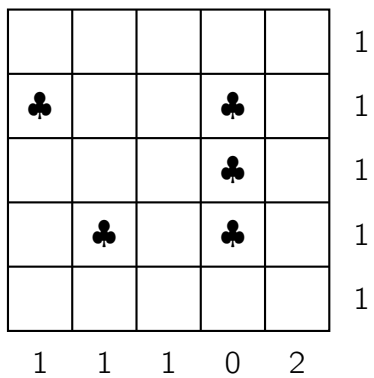

Tentes 31 *

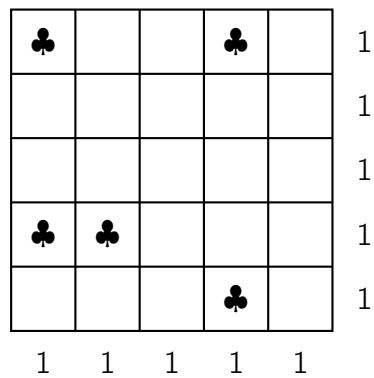

Tentes 32

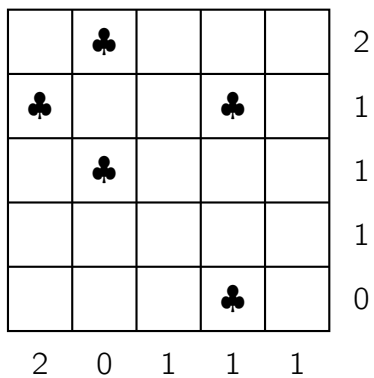

Tentes 32 *

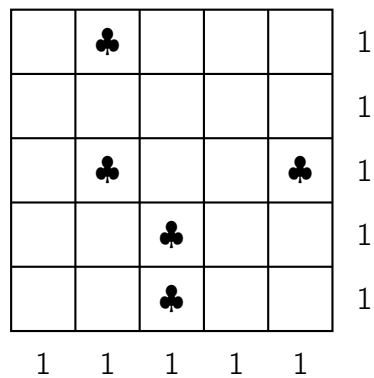

Participant

Classe 2024-2025

Participant

Classe 2024-2025

Tracks 29

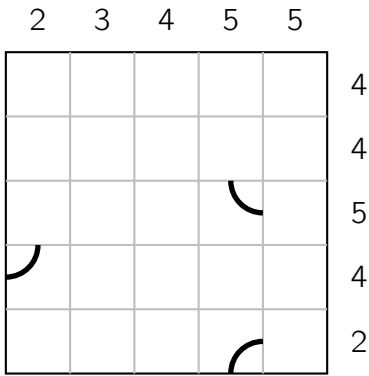

Tracks 29 *

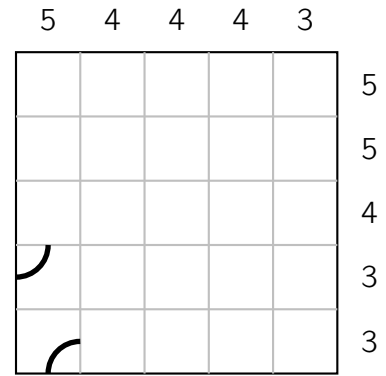

Tracks 30

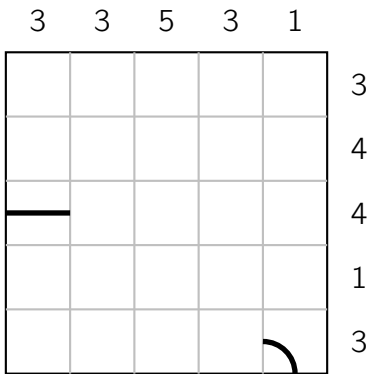

Tracks 30 *

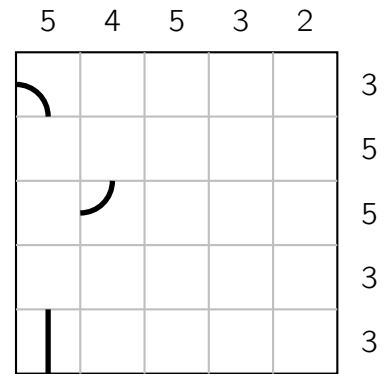

Tracks 31

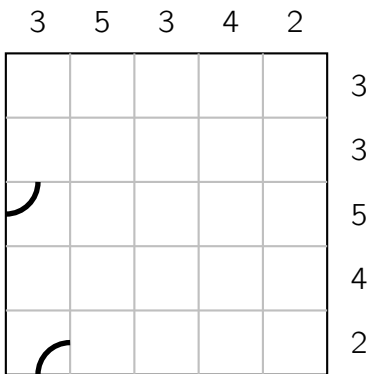

Tracks 31 *

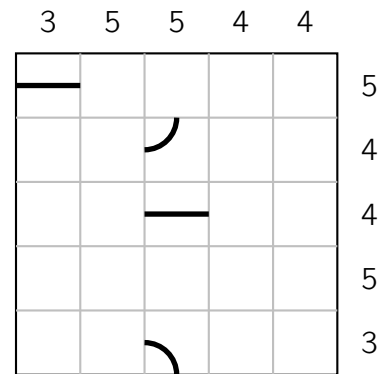

Tracks 32

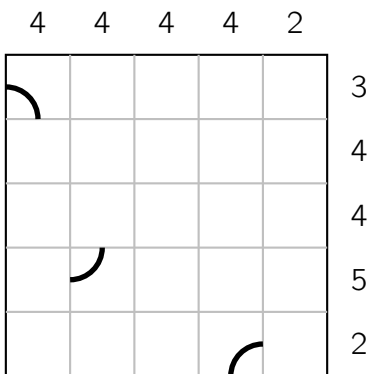

Tracks 32 *

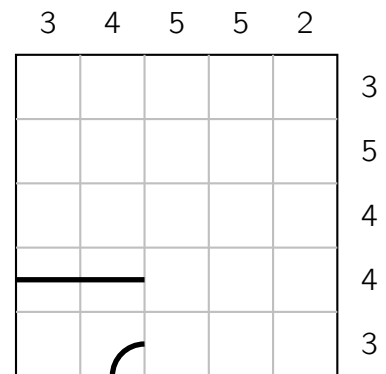

Participant

Classe 2024-2025

Participant

Classe 2024-2025

Corrigé 29

0	0	1	1	0	1
0	1	0	0	1	1
1	0	0	1	1	0
0	1	1	0	0	1
1	1	0	0	1	0
1	0	1	1	0	0

Corrigé 29 *

0	0	1	1	0	1
1	0	1	0	1	0
0	1	0	0	1	1
0	1	0	1	0	1
1	0	1	1	0	0
1	1	0	0	1	0

Corrigé 30

0	1	0	1	1	0
0	0	1	0	1	1
1	0	0	1	0	1
1	1	0	0	1	0
0	1	1	0	0	1
1	0	1	1	0	0

Corrigé 30 *

1	0	0	1	0	1
1	0	1	0	1	0
0	1	0	0	1	1
0	0	1	1	0	1
1	1	0	1	0	0
0	1	1	0	1	0

Corrigé 31

0	1	0	0	1	1
1	0	1	0	1	0
1	0	0	1	0	1
0	1	0	1	1	0
0	1	1	0	0	1
1	0	1	1	0	0

Corrigé 31 *

1	0	1	1	0	0
1	1	0	0	1	0
0	1	0	1	0	1
1	0	1	0	1	0
0	0	1	1	0	1
0	1	0	0	1	1

Corrigé 32

1	0	0	1	0	1
0	1	0	0	1	1
1	0	1	0	1	0
0	0	1	1	0	1
1	1	0	1	0	0
0	1	1	0	1	0

Corrigé 32 *

1	0	1	0	1	0
1	1	0	0	1	0
0	1	0	1	0	1
1	0	1	1	0	0
0	1	0	0	1	1
0	0	1	0	0	1

Corrigé 29

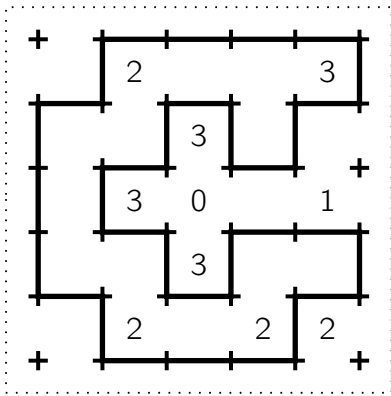

Corrigé 29 *

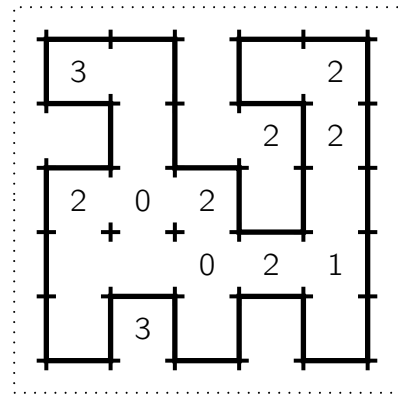

Corrigé 30

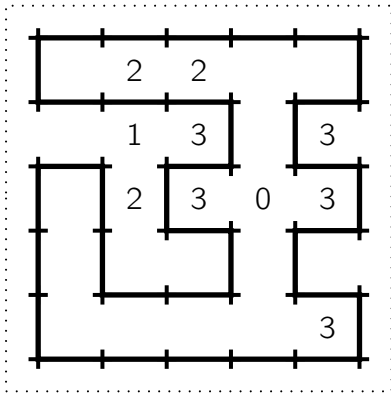

Corrigé 30 *

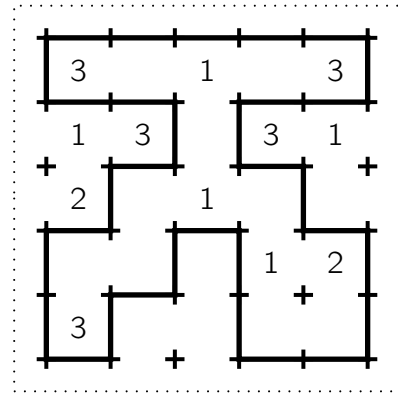

Corrigé 31

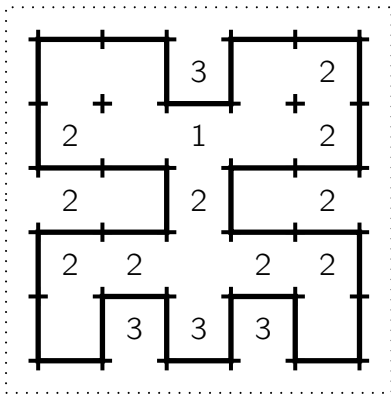

Corrigé 31 *

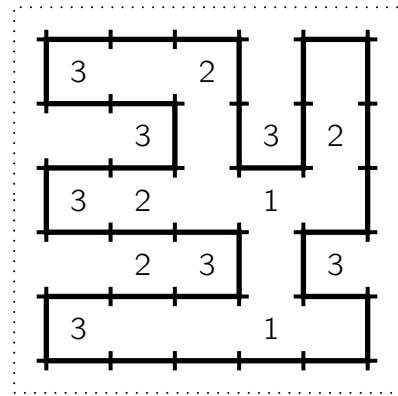

Corrigé 32

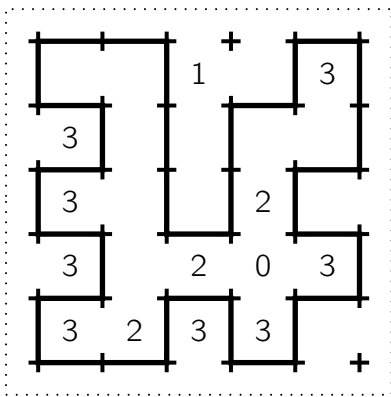

Corrigé 32 *

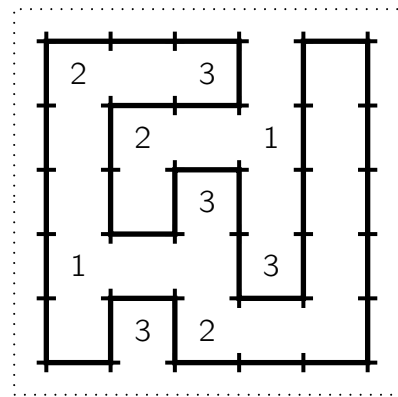

Corrigé 29

0	3	0 3		1
2	2	1	2	0
0	2	1	2	3
0	1	3 3		1

0·0	0·1	0·2	0·3	1·1
1·2	1·3	2·2	2·3	3·3

Corrigé 30

3	1	2	1	0
0	0	3	0	2
3	2	2	3	1
1	0	2	3	1

0·0	0·1	0·2	0·3	1·1
1·2	1·3	2·2	2·3	3·3

Corrigé 31

1	2 3		0	2
0	2	3	0	3
1	1	1	2	2
1	0 0		3	3

0·0	0·1	0·2	0·3	1·1
1·2	1·3	2·2	2·3	3·3

Corrigé 32

2	1	3	2	2
3	0 0		2	1
1	3	3	0	1
0	1	2	3	0

0·0	0·1	0·2	0·3	1·1
1·2	1·3	2·2	2·3	3·3

Corrigé 29 *

0	3	1	3	3
0	1	1	2	2
2	0 0		1	0
2	3	2	3	1

0·0	0·1	0·2	0·3	1·1
1·2	1·3	2·2	2·3	3·3

Corrigé 30 *

3	0	0	2	0
2	2	0	3	1
1	1	1	3	0
3	3	1	2	2

0·0	0·1	0·2	0·3	1·1
1·2	1·3	2·2	2·3	3·3

Corrigé 31 *

0	2	3	3	0
1	3	1	1	0
1	2	0	1	3
2	2	0	2	3

0·0	0·1	0·2	0·3	1·1
1·2	1·3	2·2	2·3	3·3

Corrigé 32 *

3	2	2	3	0
1	1	1	1	3
2	3	3	0	2
1	0	0	0	2

0·0	0·1	0·2	0·3	1·1
1·2	1·3	2·2	2·3	3·3

	4	1	2	3	
	↓	↓	↓	↓	
2→	1	4	3	2	←3
2→	2	1	4	3	←2
2→	3	2	1	4	←1
1→	4	3	2	1	←4
	↑	↑	↑	↑	
	1	2	2	2	

Corrigé 29

	3	2	3	1	
	↓	↓	↓	↓	
3→	1	3	2	4	←1
2→	2	4	1	3	←2
1→	4	2	3	1	←3
2→	3	1	4	2	←2
	↑	↑	↑	↑	
	2	3	1	3	

Corrigé 30

	4	1	3	2	
	↓	↓	↓	↓	
2→	1	4	2	3	←2
3→	2	1	3	4	←1
2→	3	2	4	1	←2
1→	4	3	1	2	←3
	↑	↑	↑	↑	
	1	2	2	2	

Corrigé 31

	2	3	2	1	
	↓	↓	↓	↓	
3→	2	1	3	4	←1
1→	4	3	1	2	←3
2→	3	2	4	1	←2
2→	1	4	2	3	←2
	↑	↑	↑	↑	
	3	1	2	2	

Corrigé 32

Corrigé 29 *

		2		2	
		↓		↓	
→	4	2	1	3	←
→	2	4	3	1	←
→	1	3	4	2	←
→	3	1	2	4	←
		↑		↑	
		3			

Corrigé 30 *

	↓	↓	↓	↓	
→	4	1	3	2	←3
→	1	4	2	3	←2
→	3	2	4	1	←
→	2	3	1	4	←
		↑		↑	
		3		2	

Corrigé 31 *

			2		
			↓		
→	2	4	1	3	←
→	3	2	4	1	←
→	1	3	2	4	←
→	4	1	3	2	←
			↑		
			1		

Corrigé 32 *

	↓	↓	↓	↓	
→	2	3	1	4	←
2→	1	4	3	2	←
→	4	1	2	3	←
2→	3	2	4	1	←
			↑		
			2		

Corrigé 29

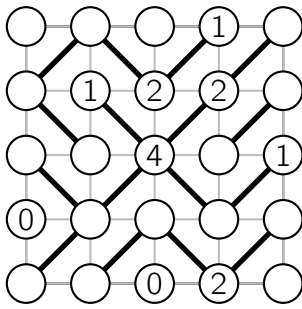

Corrigé 29 *

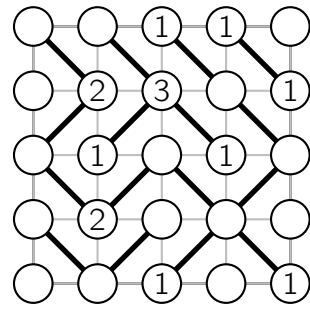

Corrigé 30

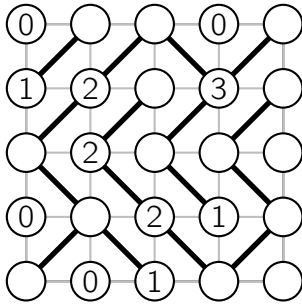

Corrigé 30 *

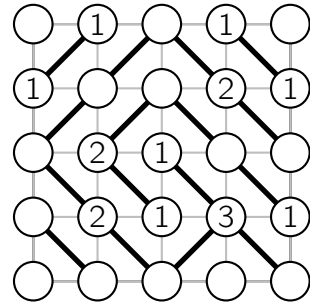

Corrigé 31

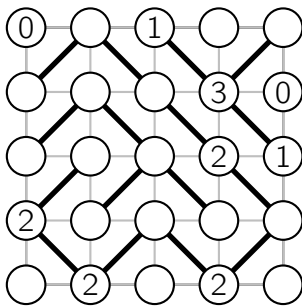

Corrigé 31 *

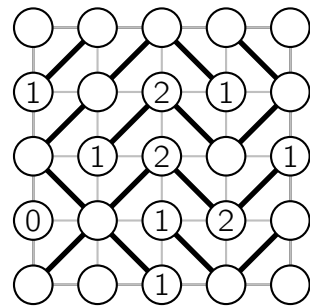

Corrigé 32

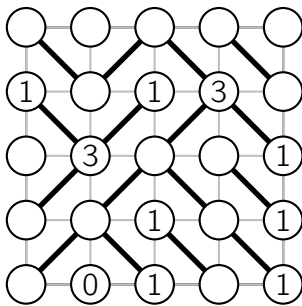

Corrigé 32 *

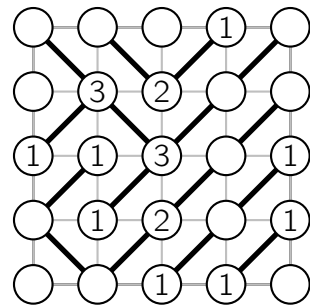

Corrigé 29

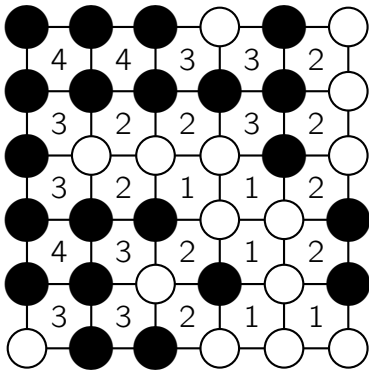

Corrigé 29 *

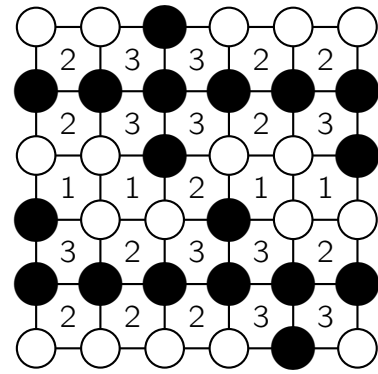

Corrigé 30

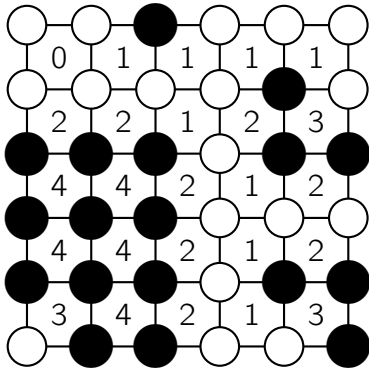

Corrigé 30 *

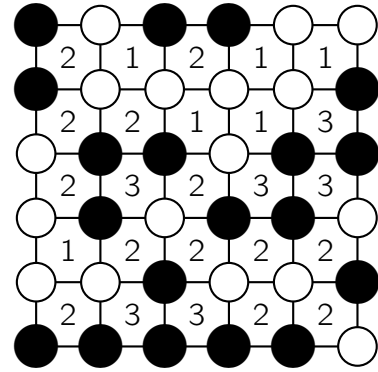

Corrigé 31

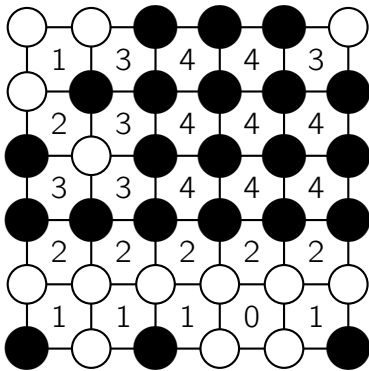

Corrigé 31 *

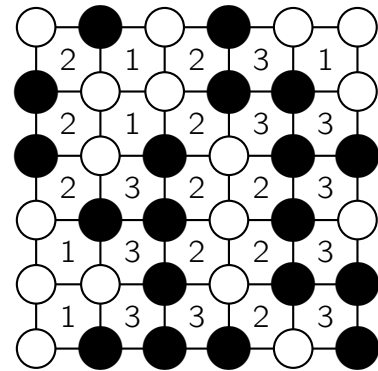

Corrigé 32

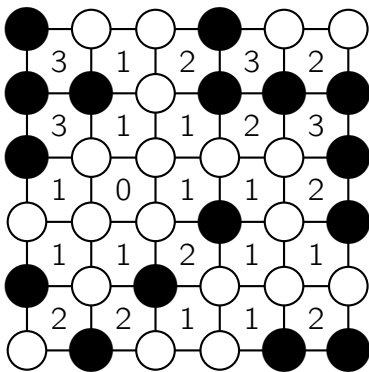

Corrigé 32 *

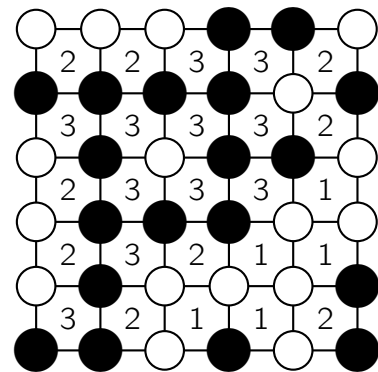

Corrigé 29

		△	♣	△	2
△	♣			♣	1
			♣		0
			△		1
♣	△				1
1	1	1	1	1	

Corrigé 29 *

	△	♣			1
		♣	△		1
△				♣	1
♣		♣		△	1
		△			1
1	1	1	1	1	

Corrigé 30

		△	♣		1
♣				♣	0
△		△		△	3
		♣			0
	♣	△			1
1	0	3	0	1	

Corrigé 30 *

△					1
♣		△		♣	1
	♣	♣		△	1
	△				1
		♣	△		1
1	1	1	1	1	

Corrigé 31

△					1
♣			♣	△	1
		△	♣		1
	♣		♣	△	1
	△				1
1	1	1	0	2	

Corrigé 31 *

♣	△		♣		1
			△		1
△					1
♣	♣	△			1
			♣	△	1
1	1	1	1	1	

Corrigé 32

△	♣	△			2
♣			♣	△	1
△	♣				1
			△		1
			♣		0
2	0	1	1	1	

Corrigé 32 *

	♣	△			1
				△	1
△	♣			♣	1
		♣	△		1
	△	♣			1
1	1	1	1	1	

Corrigé 29

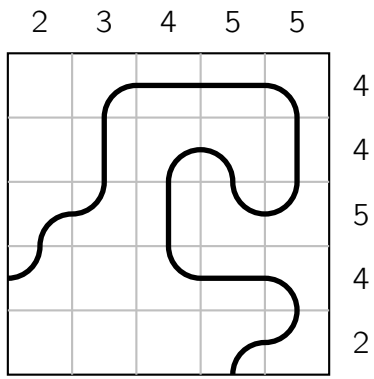

Corrigé 29 *

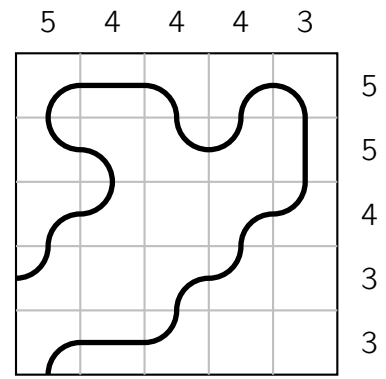

Corrigé 30

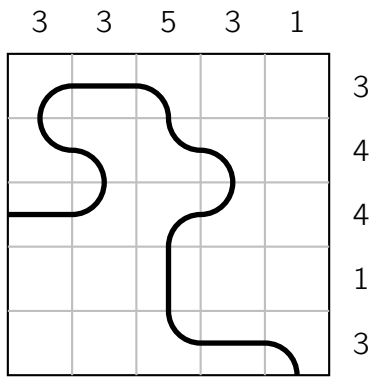

Corrigé 30 *

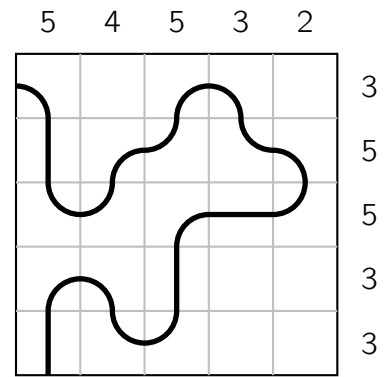

Corrigé 31

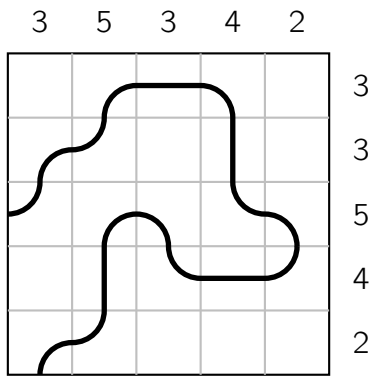

Corrigé 31 *

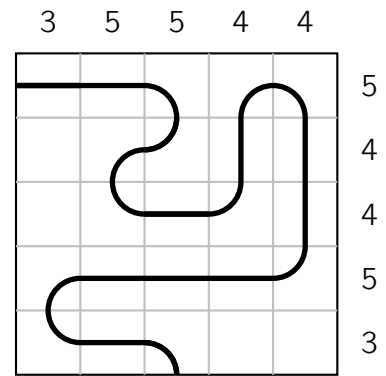

Corrigé 32

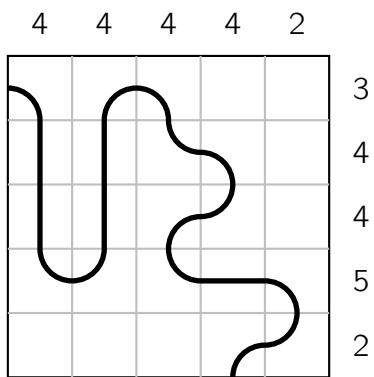

Corrigé 32 *

