

Binaro 25

	0				0
	0		0		
		0	0		0
				0	0
		1			
			0		

Binaro 25 *

			1	0	
1					1
			0		
0			1		
	1			0	

Binaro 26

		1		1	
		1			
	0				
			0		
	0		0		0

Binaro 26 *

1					
			0		
1					1
		1		1	
			0	1	

Binaro 27

		0			0
	0				
1				0	
		0		0	
	0	0			

Binaro 27 *

				1	
		0			
				0	
0					0
0			0		
			0		1

Binaro 28

0				0	
		0		0	0
0		1			
0			1		
			1	1	

Binaro 28 *

1					
			0		
1					1
		1		1	
			0	1	

Participant

Classe 2024-2025

Participant

Classe 2024-2025

Clôtures 25

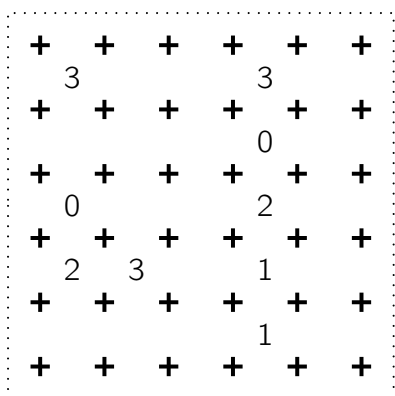

Clôtures 25 *

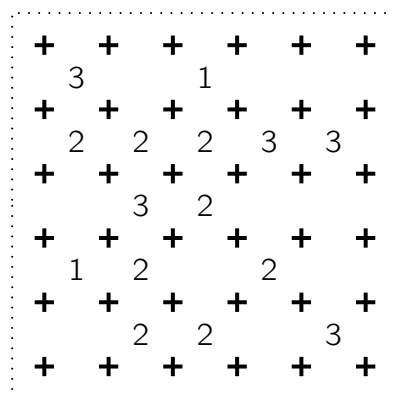

Clôtures 26

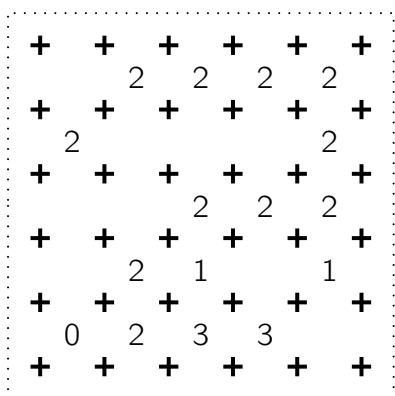

Clôtures 26 *

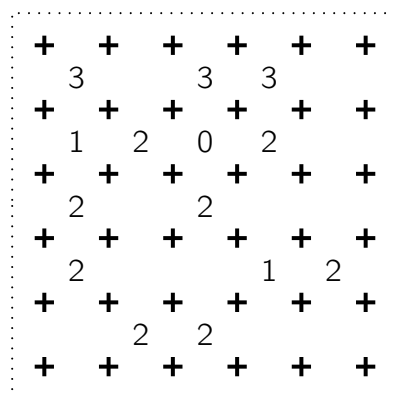

Clôtures 27

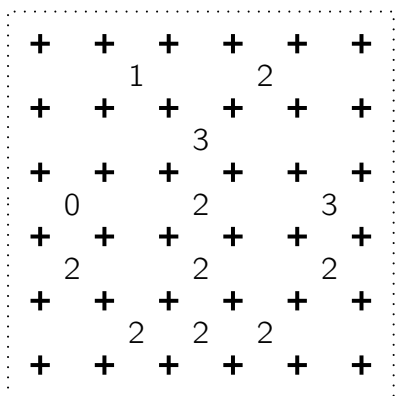

Clôtures 27 *

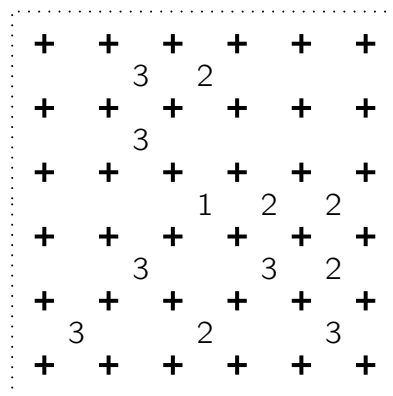

Clôtures 28

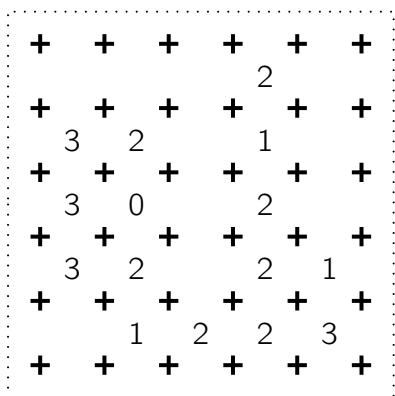

Clôtures 28 *

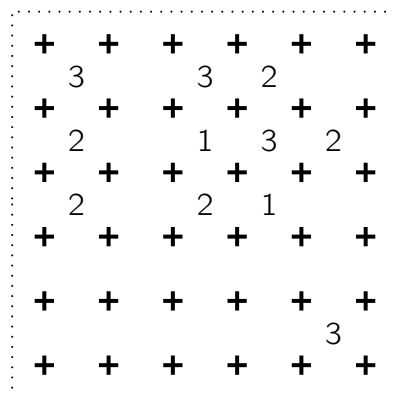

Participant

Classe 2024-2025

Participant

Classe 2024-2025

Dominos 25

0	2	1	3	3
0	3	2	0	3
1	1	2	1	2
1	3	0	2	0

0·0	0·1	0·2	0·3	1·1
1·2	1·3	2·2	2·3	3·3

Dominos 25 *

2	1	3	2	0
3	1	3	2	0
2	0	0	0	3
2	1	3	1	1

0·0	0·1	0·2	0·3	1·1
1·2	1·3	2·2	2·3	3·3

Dominos 26

3	2	0	3	2
3	3	1	2	0
0	3	1	2	0
2	1	1	0	1

0·0	0·1	0·2	0·3	1·1
1·2	1·3	2·2	2·3	3·3

Dominos 26 *

2	0	2	2	0
2	0	3	1	3
1	2	1	1	1
3	3	3	0	0

0·0	0·1	0·2	0·3	1·1
1·2	1·3	2·2	2·3	3·3

Dominos 27

0	0	2	0	1
1	1	3	0	2
2	3	1	1	3
3	2	2	0	3

0·0	0·1	0·2	0·3	1·1
1·2	1·3	2·2	2·3	3·3

Dominos 27 *

3	0	1	1	3
2	3	1	1	1
0	3	2	0	0
0	2	2	2	1

0·0	0·1	0·2	0·3	1·1
1·2	1·3	2·2	2·3	3·3

Dominos 28

2	3	2	1	0
2	3	1	3	0
1	0	2	0	3
2	1	1	0	3

0·0	0·1	0·2	0·3	1·1
1·2	1·3	2·2	2·3	3·3

Dominos 28 *

0	3	1	3	1
0	2	1	3	0
1	2	0	0	3
2	3	1	2	2

0·0	0·1	0·2	0·3	1·1
1·2	1·3	2·2	2·3	3·3

Participant

Classe 2024-2025

Participant

Classe 2024-2025

Gratte-ciel 25

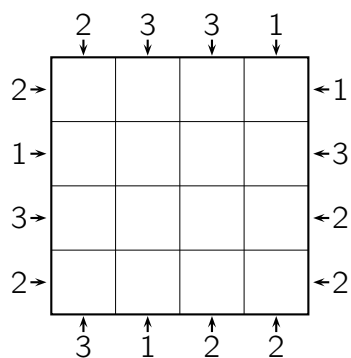

Gratte-ciel 25 *

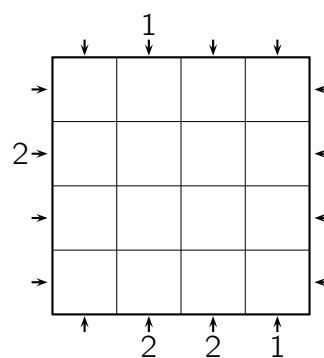

Gratte-ciel 26

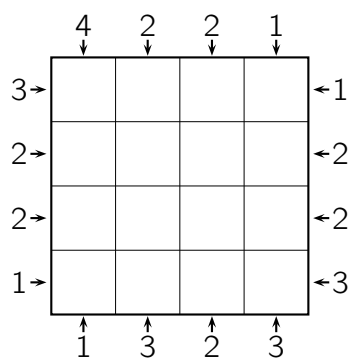

Gratte-ciel 26 *

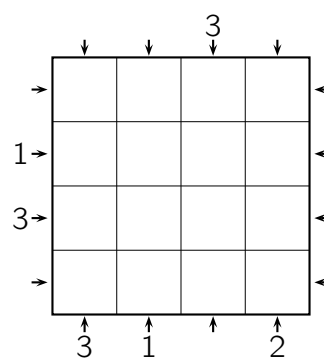

Gratte-ciel 27

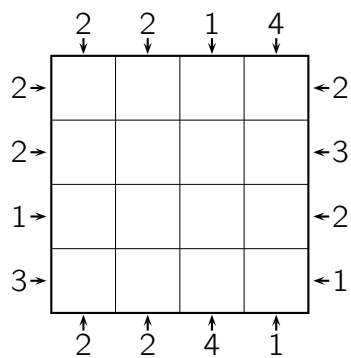

Gratte-ciel 27 *

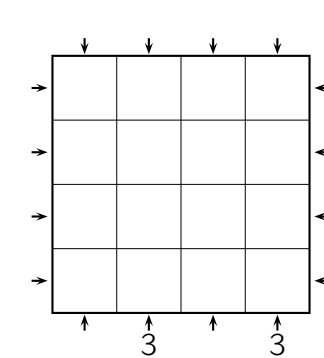

Gratte-ciel 28

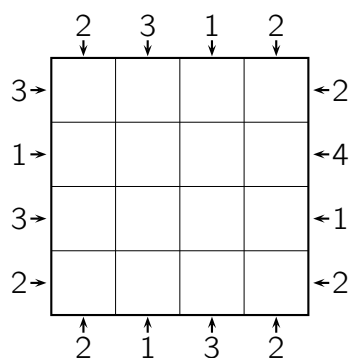

Gratte-ciel 28 *

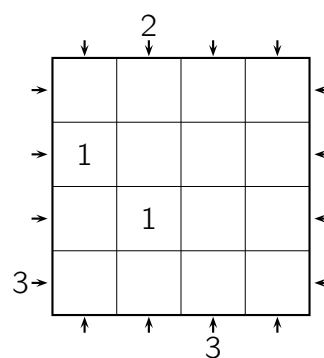

Participant

Classe 2024-2025

Participant

Classe 2024-2025

Slants 25

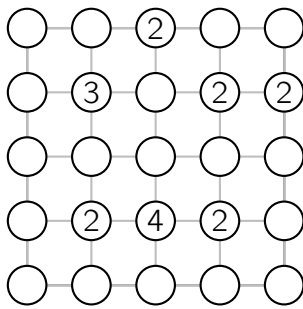

Slants 25 *

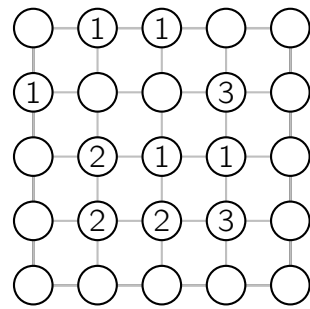

Slants 26

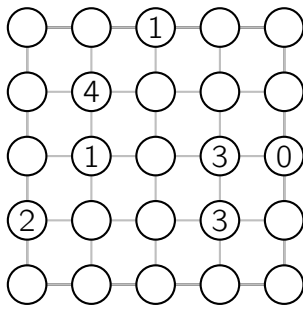

Slants 26 *

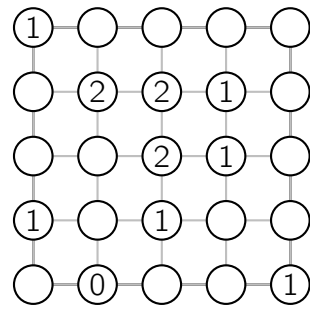

Slants 27

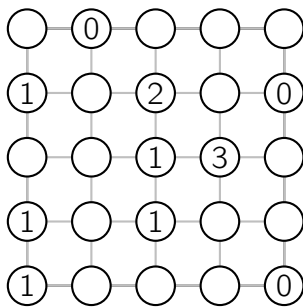

Slants 27 *

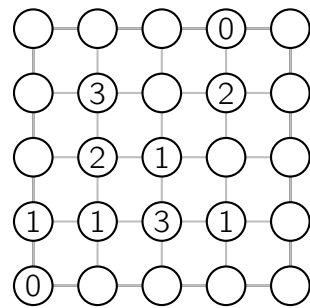

Slants 28

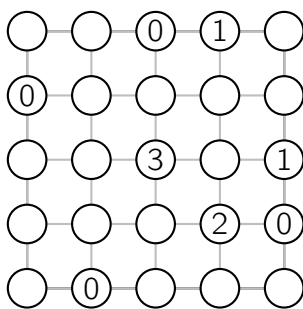

Slants 28 *

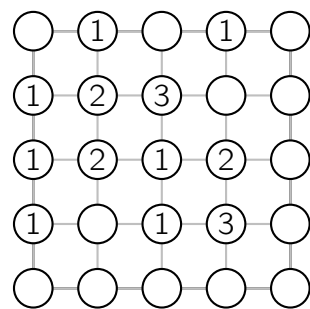

Participant

Classe 2024-2025

Participant

Classe 2024-2025

Squaro 25

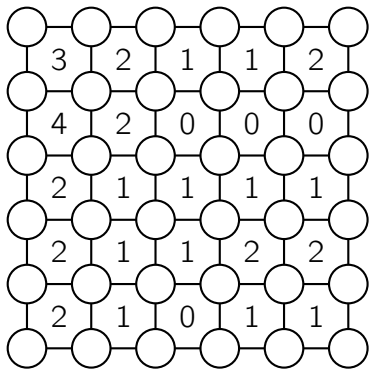

Squaro 25 *

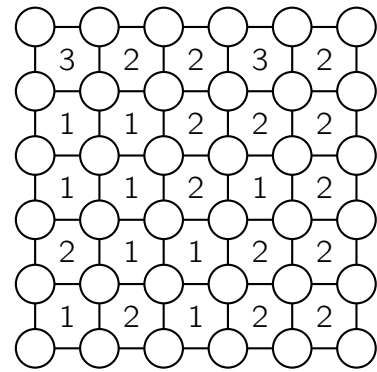

Squaro 26

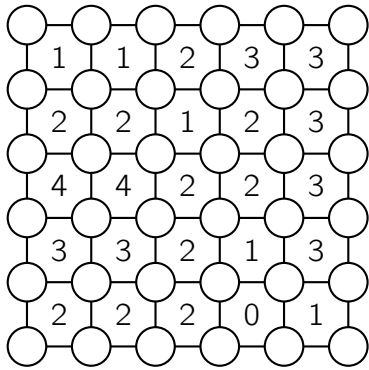

Squaro 26 *

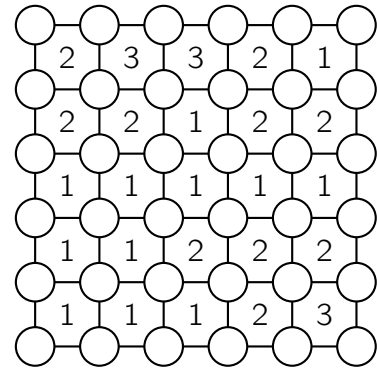

Squaro 27

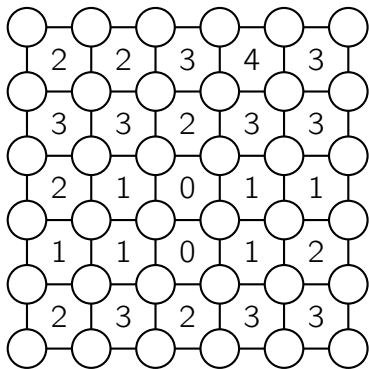

Squaro 27 *

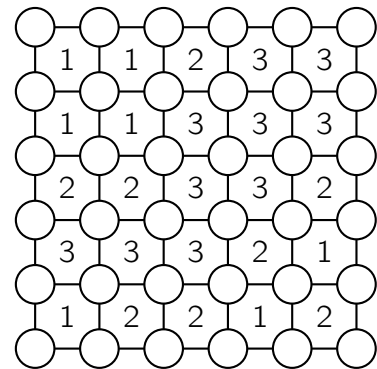

Squaro 28

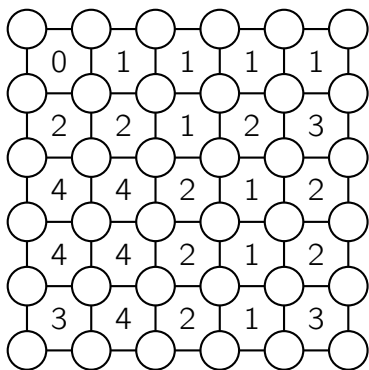

Squaro 28 *

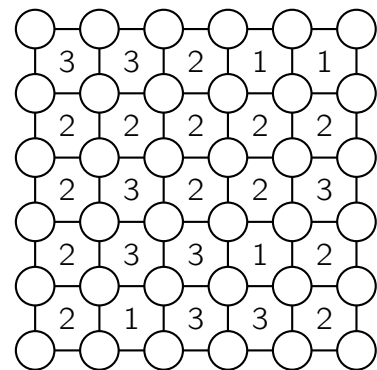

Participant

Classe 2024-2025

Participant

Classe 2024-2025

Tentes 25

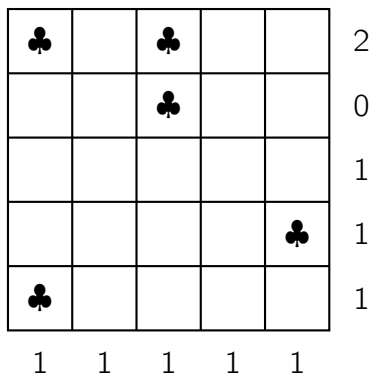

Tentes 25 *

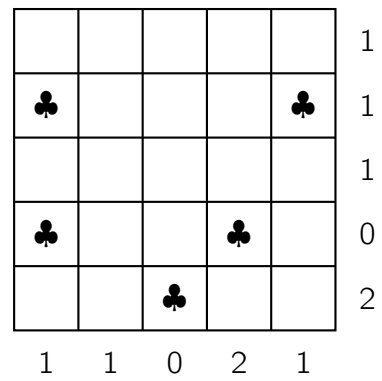

Tentes 26

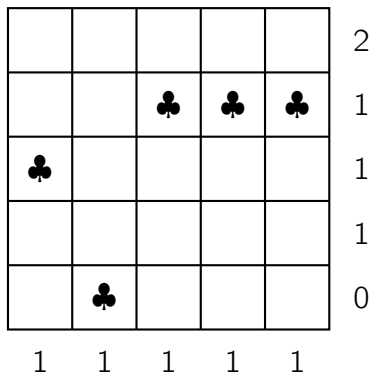

Tentes 26 *

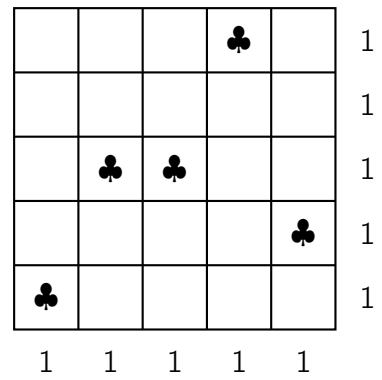

Tentes 27

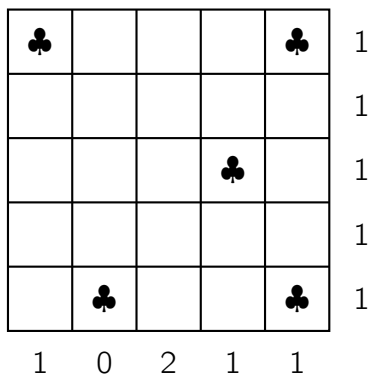

Tentes 27 *

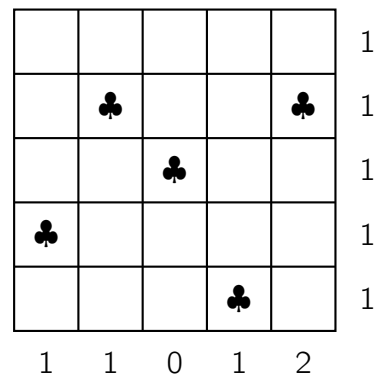

Tentes 28

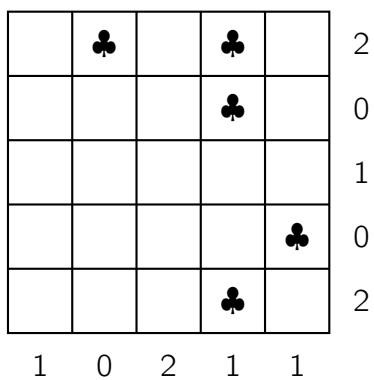

Tentes 28 *

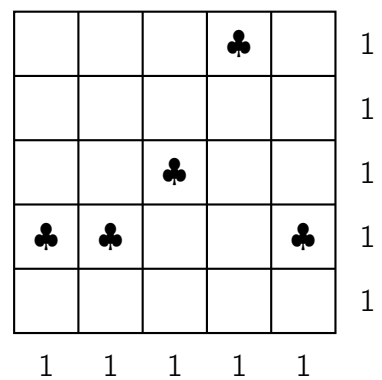

Participant

Classe 2024-2025

Participant

Classe 2024-2025

Tracks 25

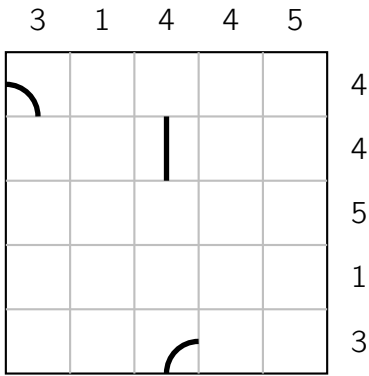

Tracks 25 *

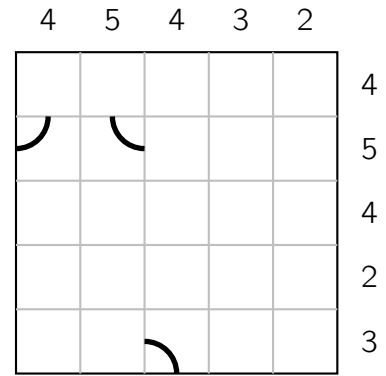

Tracks 26

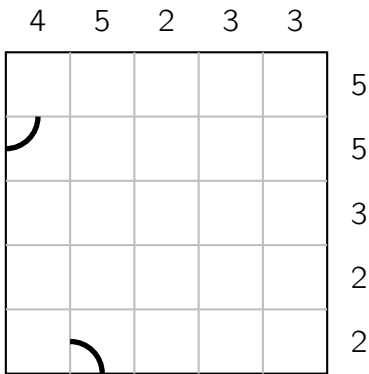

Tracks 26 *

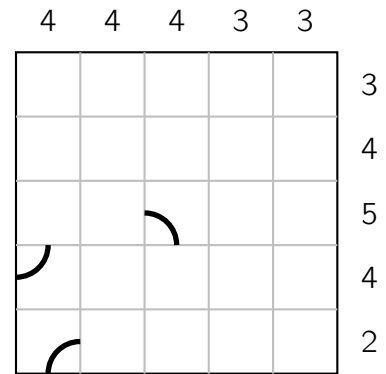

Tracks 27

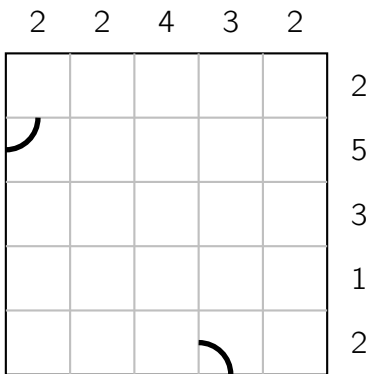

Tracks 27 *

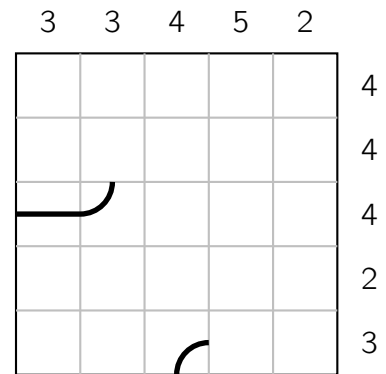

Tracks 28

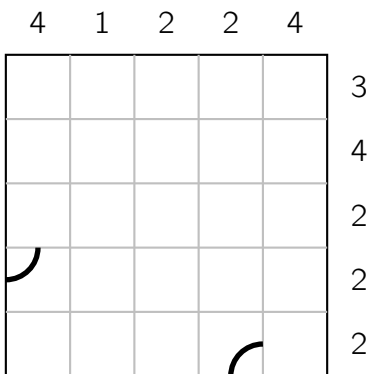

Tracks 28 *

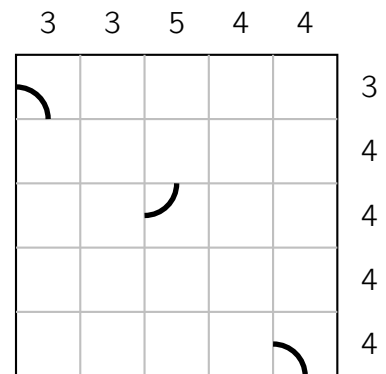

Participant

Classe 2024-2025

Participant

Classe 2024-2025

Corrigé 25

1	0	1	1	0	0
0	0	1	0	1	1
1	1	0	0	1	0
1	1	0	1	0	0
0	0	1	1	0	1
0	1	0	0	1	0

Corrigé 25 *

1	0	1	1	0	0
0	1	0	0	1	1
1	0	0	1	0	1
1	0	1	0	1	0
0	1	0	1	1	0
0	1	1	0	0	1

Corrigé 26

0	1	1	0	1	0
1	0	1	1	0	0
1	0	0	1	0	1
0	1	0	0	1	1
1	0	1	0	1	0
0	1	0	1	0	1

Corrigé 26 *

1	0	1	1	0	0
0	1	1	0	1	0
1	0	0	1	0	1
0	1	0	1	0	1
1	0	1	0	1	0
0	1	0	0	1	1

Corrigé 27

0	1	0	1	1	0
1	0	1	0	1	0
1	0	1	0	0	1
0	1	0	1	0	1
1	0	0	1	1	0
0	1	1	0	0	1

Corrigé 27 *

1	0	0	1	1	0
0	1	0	0	1	1
1	0	1	1	0	0
0	1	0	1	1	0
0	1	1	0	0	1
1	0	1	0	0	1

Corrigé 28

0	1	1	0	0	1
1	0	1	0	1	0
1	1	0	1	0	0
0	0	1	0	1	1
0	1	0	1	0	1
1	0	0	1	1	0

Corrigé 28 *

1	0	1	1	0	0
0	1	1	0	1	0
1	0	0	1	0	1
0	1	0	1	0	1
1	0	1	0	1	0
0	1	0	0	1	1

Corrigé 25

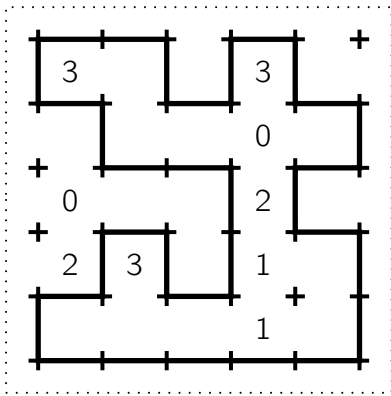

Corrigé 25 *

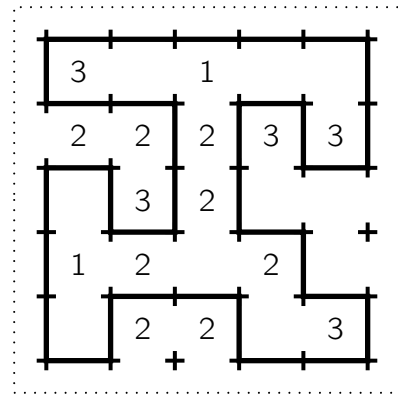

Corrigé 26

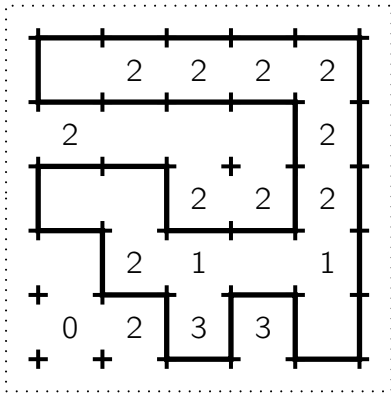

Corrigé 26 *

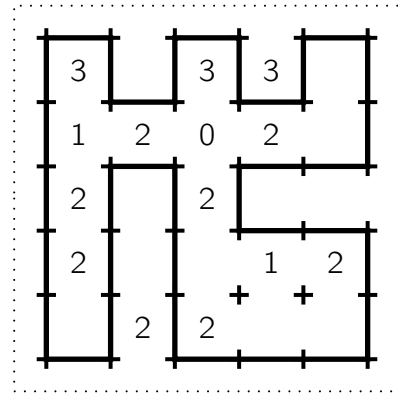

Corrigé 27

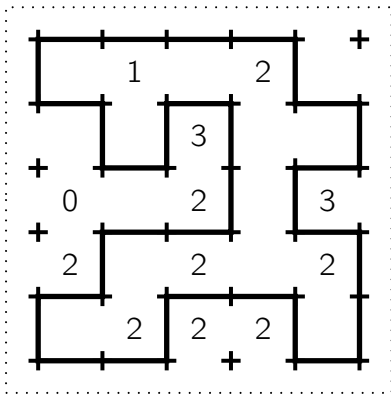

Corrigé 27 *

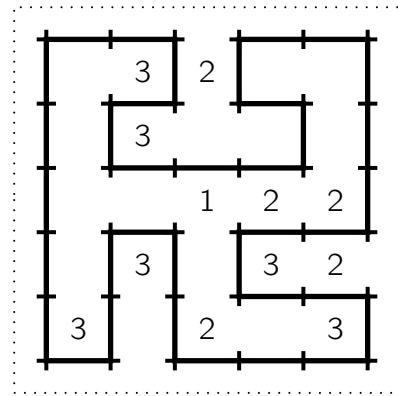

Corrigé 28

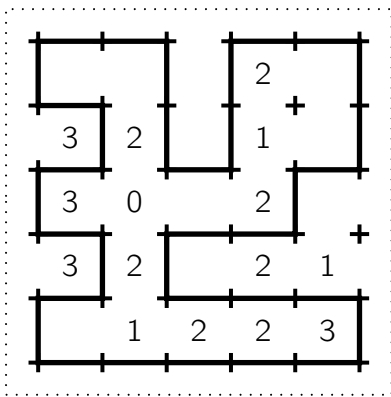

Corrigé 28 *

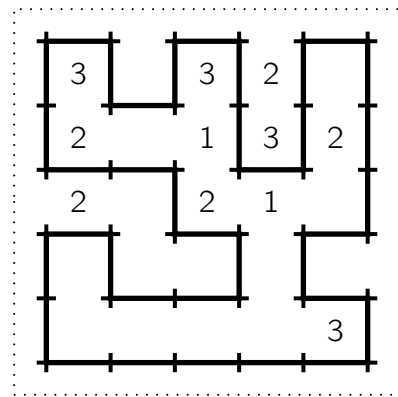

Corrigé 25

0	2 1		3 3	
0	3	2	0	3
1	1	2	1	2
1	3 0		2 0	

0·0	0·1	0·2	0·3	1·1
1·2	1·3	2·2	2·3	3·3

Corrigé 26

3	2 0		3 2	
3	3	1	2	0
0	3	1	2	0
2	1	1	0	1

0·0	0·1	0·2	0·3	1·1
1·2	1·3	2·2	2·3	3·3

Corrigé 27

0 0		2 0		1
1	1	3	0	2
2	3 1		1	3
3	2 2		0	3

0·0	0·1	0·2	0·3	1·1
1·2	1·3	2·2	2·3	3·3

Corrigé 28

2	3 2		1 0	
2	3	1	3	0
1	0 2		0	3
2	1 1		0	3

0·0	0·1	0·2	0·3	1·1
1·2	1·3	2·2	2·3	3·3

Corrigé 25 *

2	1	3	2	0
3	1	3	2	0
2 0		0	0	3
2	1	3	1	1

0·0	0·1	0·2	0·3	1·1
1·2	1·3	2·2	2·3	3·3

Corrigé 26 *

2	0	2	2 0	
2	0	3	1	3
1	2	1	1	1
3	3	3	0	0

0·0	0·1	0·2	0·3	1·1
1·2	1·3	2·2	2·3	3·3

Corrigé 27 *

3	0 1		1	3
2	3	1	1	1
0	3	2	0 0	
0	2	2	2	1

0·0	0·1	0·2	0·3	1·1
1·2	1·3	2·2	2·3	3·3

Corrigé 28 *

0	3	1	3	1
0	2	1	3	0
1	2 0		0 3	
2	3	1	2	2

0·0	0·1	0·2	0·3	1·1
1·2	1·3	2·2	2·3	3·3

Corrigé 25

	2	3	3	1	
2→	3	2	1	4	←1
1→	4	1	3	2	←3
3→	2	3	4	1	←2
2→	1	4	2	3	←2
	3	1	2	2	

Corrigé 25 *

		1			
→	2	4	3	1	←
2→	3	1	4	2	←
→	4	2	1	3	←
→	1	3	2	4	←
	3	2	2	1	

Corrigé 26

	4	2	2	1	
3→	1	3	2	4	←1
2→	2	4	1	3	←2
2→	3	2	4	1	←2
1→	4	1	3	2	←3
	1	3	2	3	

Corrigé 26 *

			3		
→	3	2	1	4	←
1→	4	1	3	2	←
3→	2	3	4	1	←
→	1	4	2	3	←
	3	1	2	2	

Corrigé 27

	2	2	1	4	
2→	3	2	4	1	←2
2→	1	4	3	2	←3
1→	4	1	2	3	←2
3→	2	3	1	4	←1
	2	2	4	1	

Corrigé 27 *

→	1	4	3	2	←3
→	2	3	1	4	←
→	4	1	2	3	←
→	3	2	4	1	←
	3	3	3	3	

Corrigé 28

	2	3	1	2	
3→	1	2	4	3	←2
1→	4	3	2	1	←4
3→	2	1	3	4	←1
2→	3	4	1	2	←2
	2	1	3	2	

Corrigé 28 *

		2			
→	3	2	4	1	←
→	1	4	2	3	←
→	4	1	3	2	←
3→	2	3	1	4	←
	3	3	3	3	

Corrigé 25

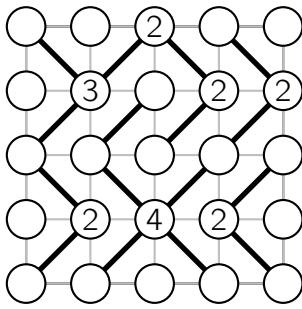

Corrigé 25 *

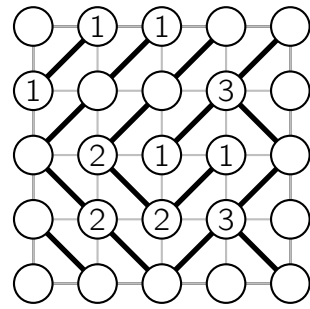

Corrigé 26

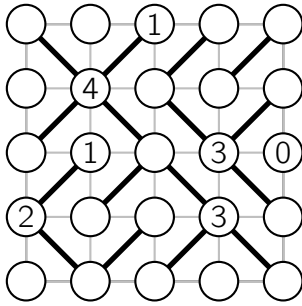

Corrigé 26 *

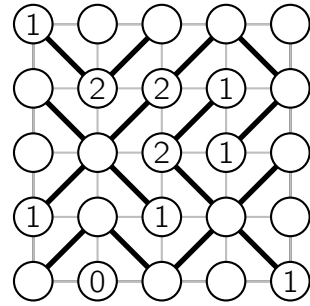

Corrigé 27

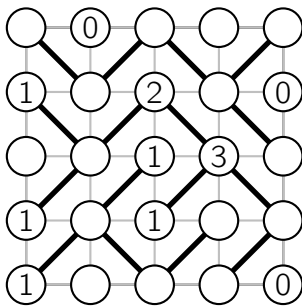

Corrigé 27 *

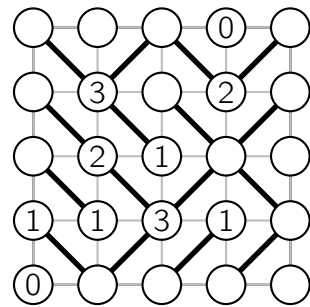

Corrigé 28

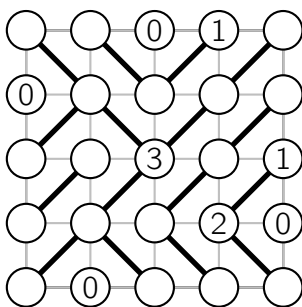

Corrigé 28 *

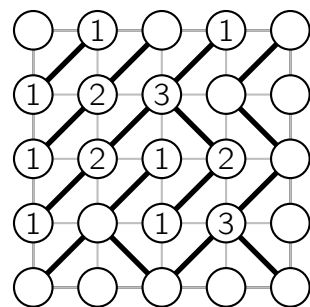

Corrigé 25

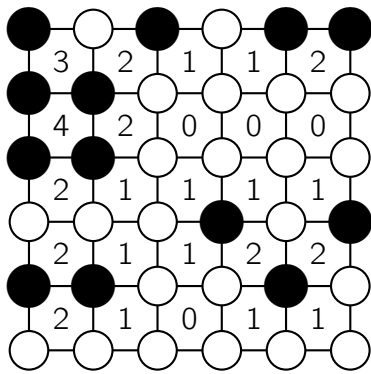

Corrigé 25 *

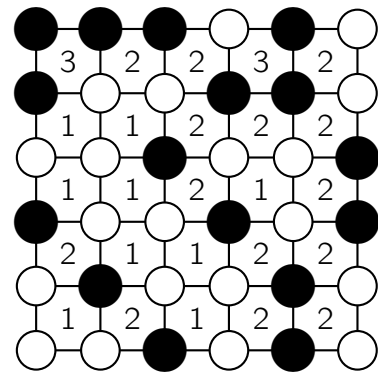

Corrigé 26

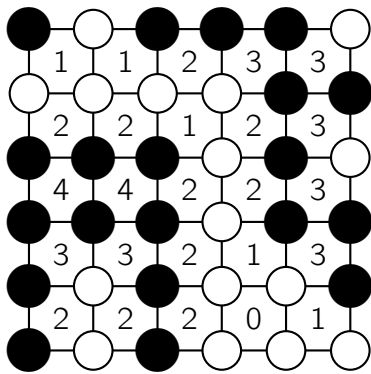

Corrigé 26 *

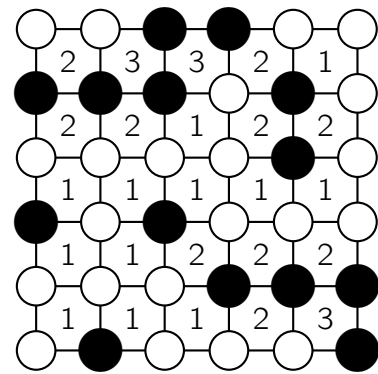

Corrigé 27

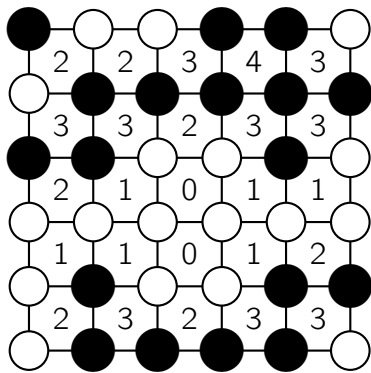

Corrigé 27 *

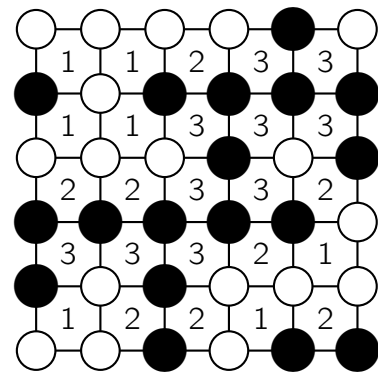

Corrigé 28

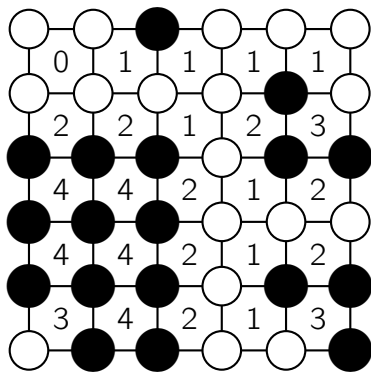

Corrigé 28 *

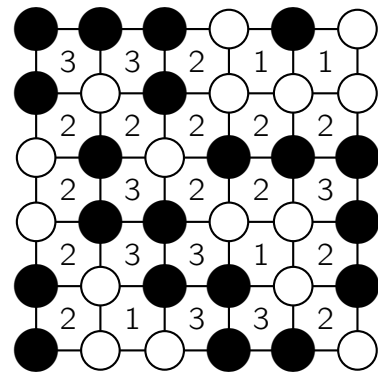

Corrigé 25

♣	△	♣	△		2
		♣			0
		△			1
△				♣	1
♣				△	1
1	1	1	1	1	

Corrigé 25 *

				△	1
♣	△			♣	1
			△		1
♣			♣		0
△		♣	△		2
1	1	0	2	1	

Corrigé 26

		△		△	2
△		♣	♣	♣	1
♣			△		1
	△				1
	♣				0
1	1	1	1	1	

Corrigé 26 *

			♣	△	1
		△			1
△	♣	♣			1
			△	♣	1
♣	△				1
1	1	1	1	1	

Corrigé 27

♣			△	♣	1
△					1
		△	♣		1
				△	1
	♣	△		♣	1
1	0	2	1	1	

Corrigé 27 *

				△	1
△	♣			♣	1
		♣	△		1
♣	△				1
			♣	△	1
1	1	0	1	2	

Corrigé 28

△	♣	△	♣		2
			♣		0
			△		1
				♣	0
		△	♣	△	2
1	0	2	1	1	

Corrigé 28 *

			♣	△	1
		△			1
△		♣			1
♣	♣		△	♣	1
	△				1
1	1	1	1	1	

Corrigé 25

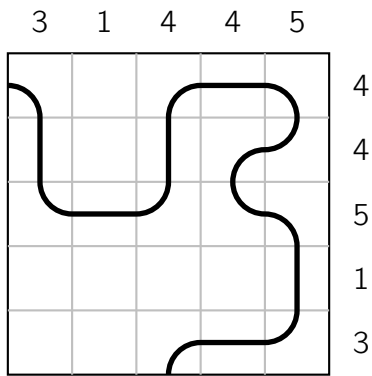

Corrigé 25 *

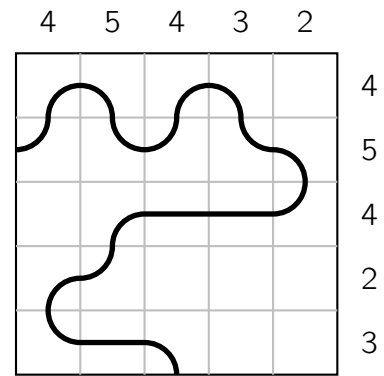

Corrigé 26

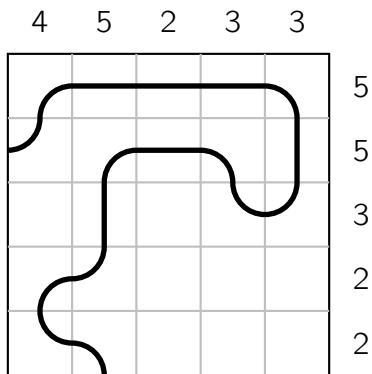

Corrigé 26 *

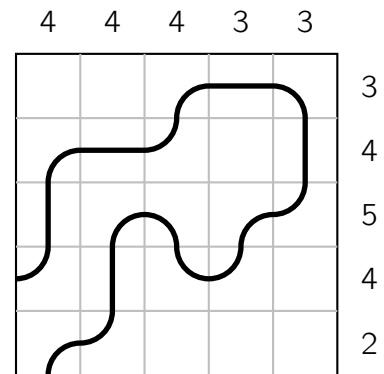

Corrigé 27

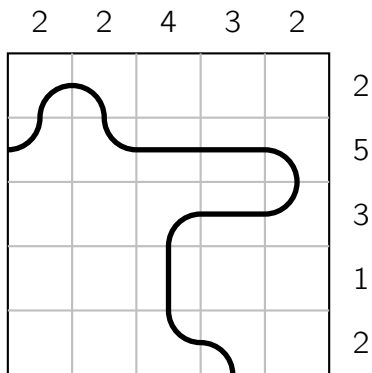

Corrigé 27 *

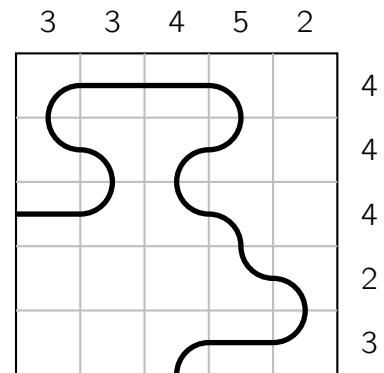

Corrigé 28

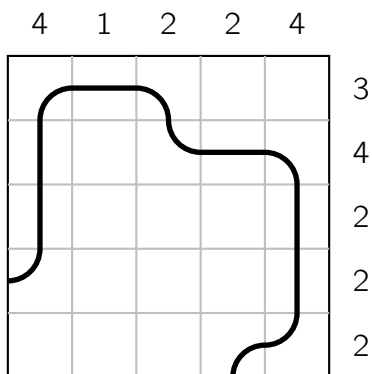

Corrigé 28 *

