

Binaro 7

	0				0
	0		0		
		0	0		0
				0	0
		1			
			0		

Slants 7

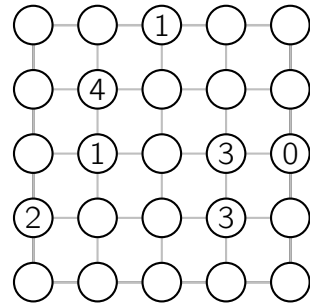

Clôtures 7

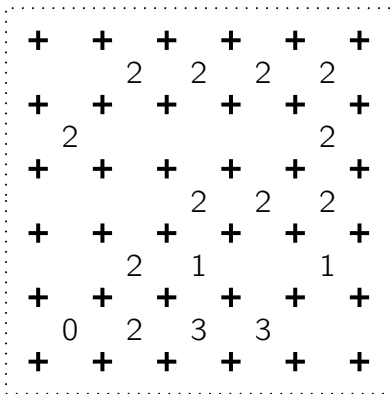

Squaro 7

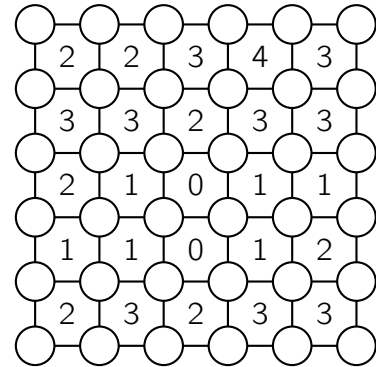

Dominos 7

2	3	2	1	0
2	3	1	3	0
1	0	2	0	3
2	1	1	0	3

0·0	0·1	0·2	0·3	1·1
1·2	1·3	2·2	2·3	3·3

Tentes 7

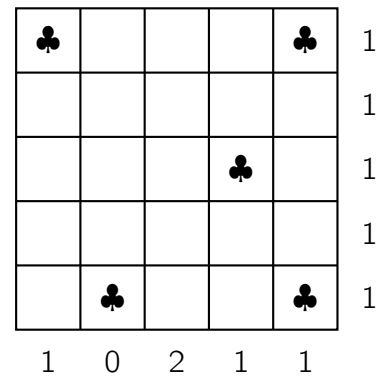

Gratte-ciel 7

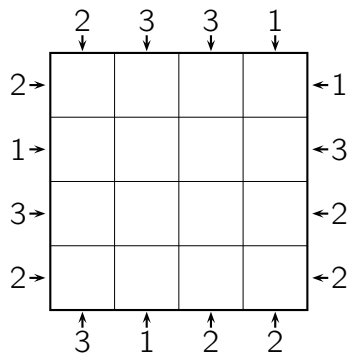

Tracks 7

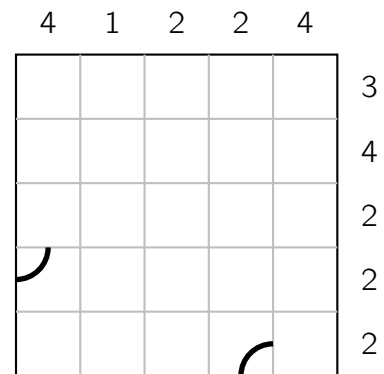

Participant

Classe 2024-2025

Corrigé 7

1	0	1	1	0	0
0	0	1	0	1	1
1	1	0	0	1	0
1	1	0	1	0	0
0	0	1	1	0	1
0	1	0	0	1	0

Corrigé 7

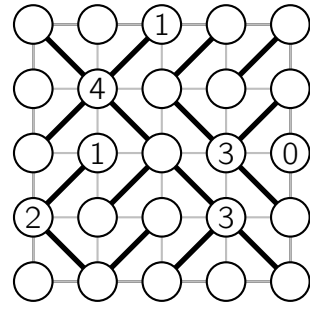

Corrigé 7

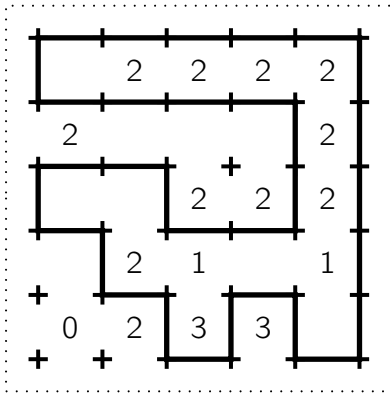

Corrigé 7

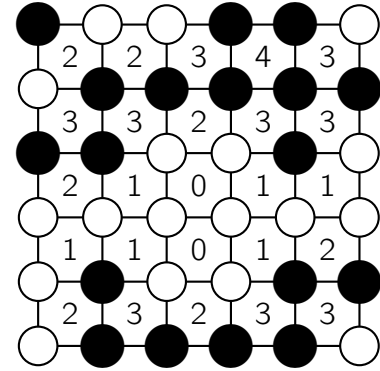

Corrigé 7

2	3	2	1	0
2	3	1	3	0
1	0	2	0	3
2	1	1	0	3

Corrigé 7

♣			△	♣	1
△					1
		△	♣		1
				△	1
	♣	△		♣	1
1	0	2	1	1	

0·0	0·1	0·2	0·3	1·1
1·2	1·3	2·2	2·3	3·3

Corrigé 7

Corrigé 7

	2	3	3	1	
	↓	↓	↓	↓	
2→	3	2	1	4	←1
1→	4	1	3	2	←3
3→	2	3	4	1	←2
2→	1	4	2	3	←2
	↑	↑	↑	↑	
	3	1	2	2	

