

**Binaro 21**

			1		
	0				
	0	0			0
					0
1			1	0	

**Binaro 21 \***

			1		
				0	
		1			
			0		
1					
	0	0			1

**Binaro 22**

1					
			1		1
	1		1	1	
0					
		1	1		

**Binaro 22 \***

				0	
	1				
0					
0			1		
		1	1		

**Binaro 23**

					0
	0	0			
			1		
		0			0
0		1	1		

**Binaro 23 \***

				0	
					1
					1
	1		0		
0			0	0	

**Binaro 24**

0					
		1			1
		1	1		1
0		0	1		1

**Binaro 24 \***

		0			
1		0			1
	0				
1					
1			1		

Participant .....

Classe ..... 2024-2025

Participant .....

Classe ..... 2024-2025

**Clôtures 21**

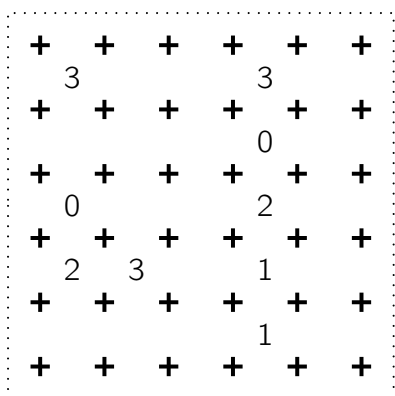

**Clôtures 21 \***

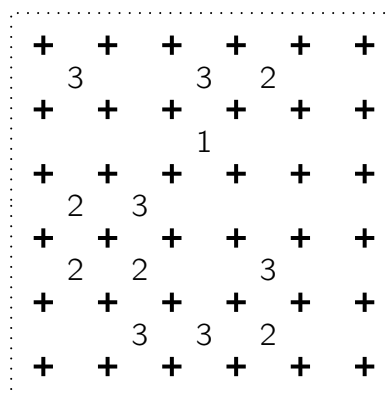

**Clôtures 22**

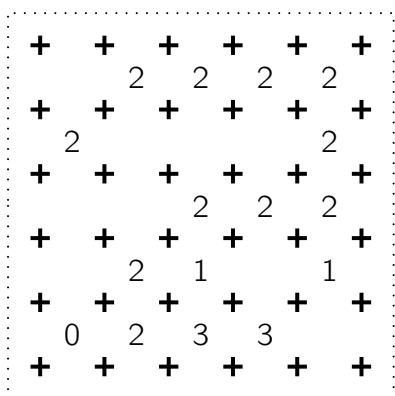

**Clôtures 22 \***

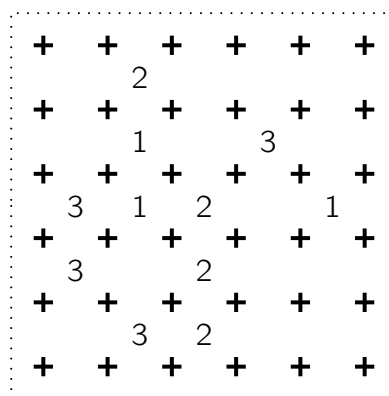

**Clôtures 23**

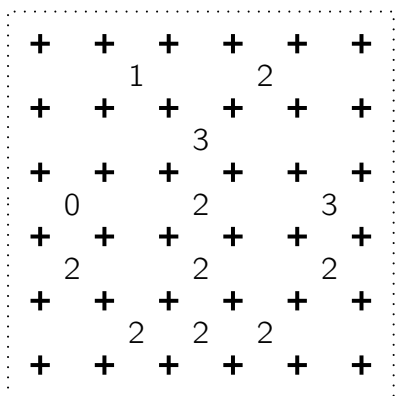

**Clôtures 23 \***

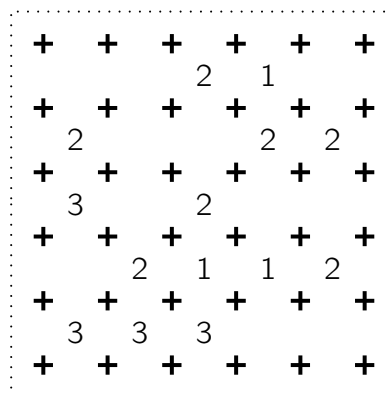

**Clôtures 24**

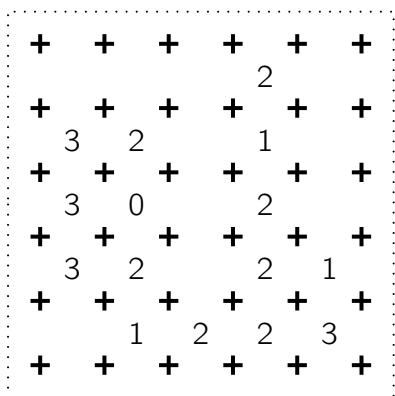

**Clôtures 24 \***

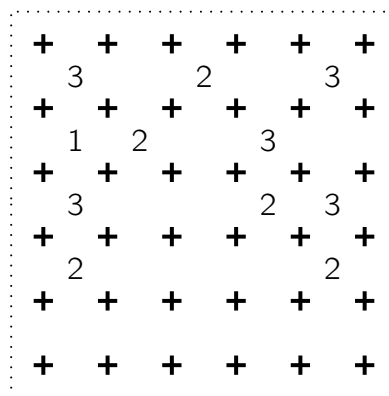

Participant .....

Classe ..... 2024-2025

Participant .....

Classe ..... 2024-2025

### Dominos 21

1	1	0	0	3
1	1	3	2	2
0	2	2	2	0
1	3	3	3	0

0·0	0·1	0·2	0·3	1·1
1·2	1·3	2·2	2·3	3·3

### Dominos 21 \*

3	2	3	1	2
2	0	0	0	1
2	3	3	2	0
1	1	3	1	0

0·0	0·1	0·2	0·3	1·1
1·2	1·3	2·2	2·3	3·3

### Dominos 22

3	3	3	2	1
0	2	0	1	1
3	2	0	2	2
0	1	1	3	0

0·0	0·1	0·2	0·3	1·1
1·2	1·3	2·2	2·3	3·3

### Dominos 22 \*

3	2	1	1	2
1	2	0	1	0
3	2	0	1	3
2	0	3	0	3

0·0	0·1	0·2	0·3	1·1
1·2	1·3	2·2	2·3	3·3

### Dominos 23

0	1	3	1	0
2	1	3	2	2
2	3	1	0	1
0	3	3	0	2

0·0	0·1	0·2	0·3	1·1
1·2	1·3	2·2	2·3	3·3

### Dominos 23 \*

2	2	0	1	1
3	3	0	0	2
1	3	0	0	2
3	2	1	1	3

0·0	0·1	0·2	0·3	1·1
1·2	1·3	2·2	2·3	3·3

### Dominos 24

0	3	2	0	1
1	1	1	2	2
2	0	3	0	0
1	3	3	3	2

0·0	0·1	0·2	0·3	1·1
1·2	1·3	2·2	2·3	3·3

### Dominos 24 \*

2	2	3	3	3
2	0	0	1	0
3	1	0	2	3
0	1	1	2	1

0·0	0·1	0·2	0·3	1·1
1·2	1·3	2·2	2·3	3·3

Participant .....

Classe ..... 2024-2025

Participant .....

Classe ..... 2024-2025

### Gratte-ciel 21

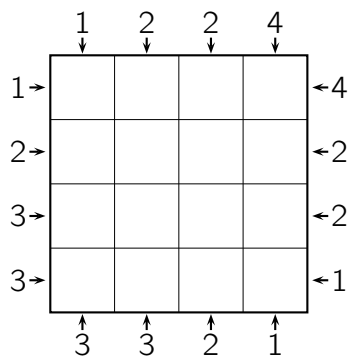

### Gratte-ciel 21 \*

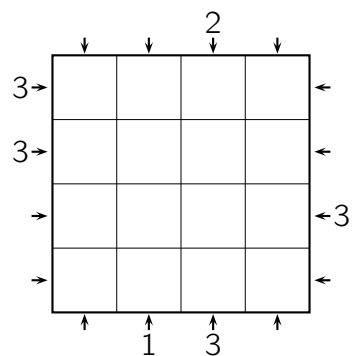

### Gratte-ciel 22

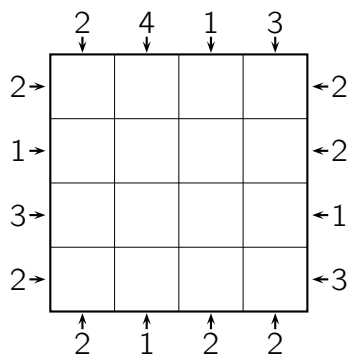

### Gratte-ciel 22 \*

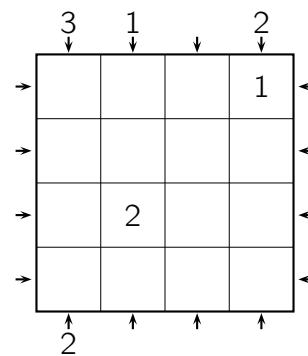

### Gratte-ciel 23

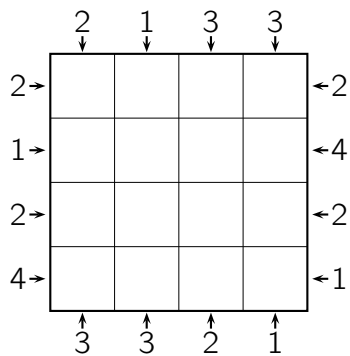

### Gratte-ciel 23 \*

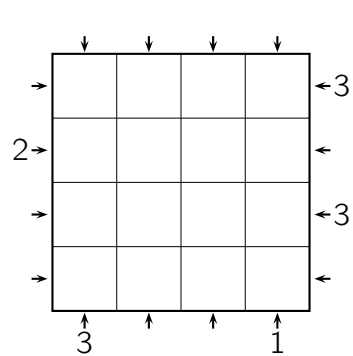

### Gratte-ciel 24

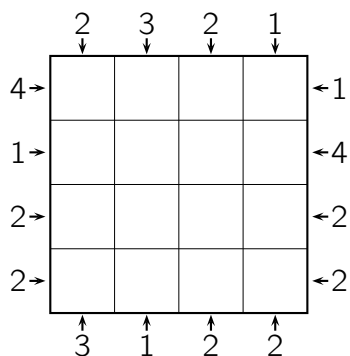

### Gratte-ciel 24 \*

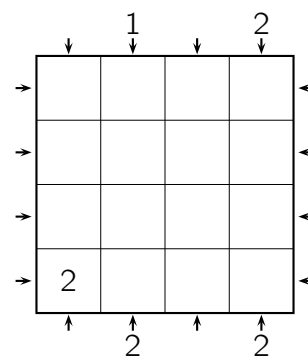

Participant .....

Classe ..... 2024-2025

Participant .....

Classe ..... 2024-2025

**Slants 21**

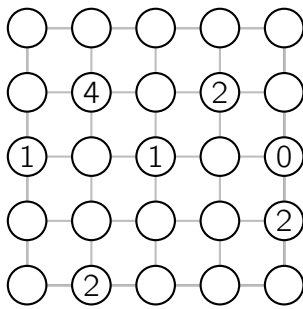

**Slants 21 \***

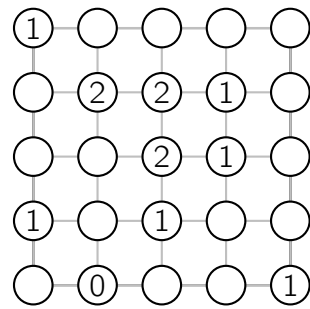

**Slants 22**

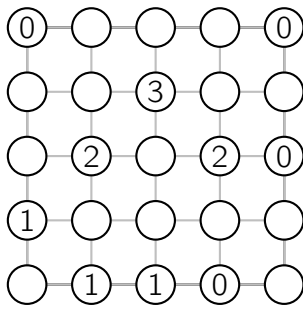

**Slants 22 \***

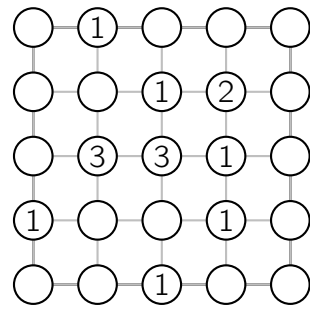

**Slants 23**

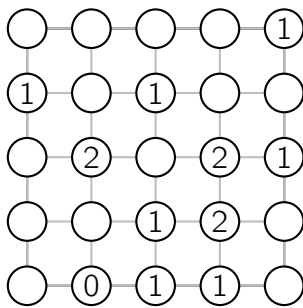

**Slants 23 \***

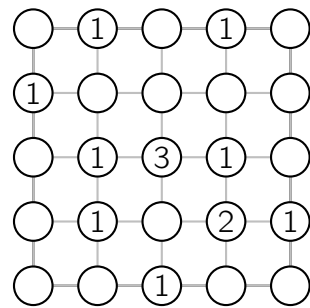

**Slants 24**

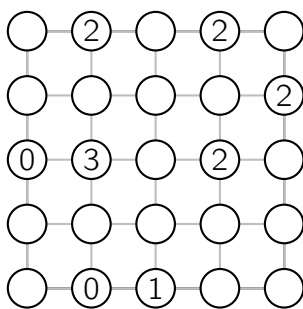

**Slants 24 \***

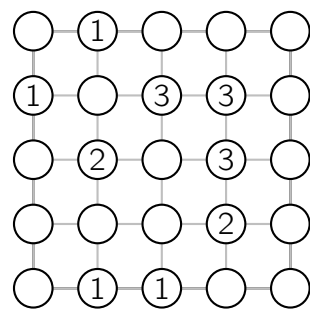

Participant .....

Classe ..... 2024-2025

Participant .....

Classe ..... 2024-2025

Squaro 21

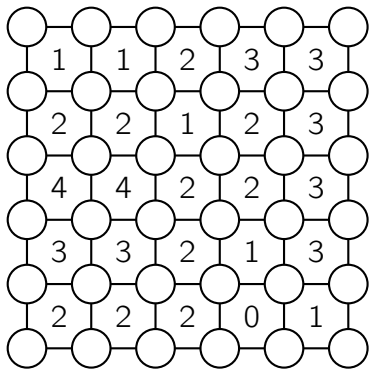

Squaro 21 \*

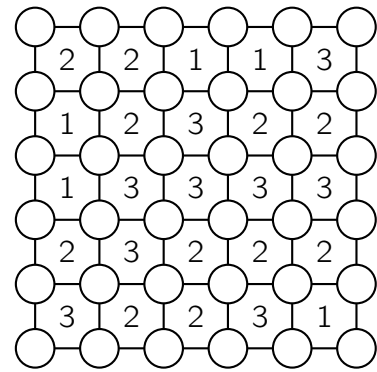

Squaro 22

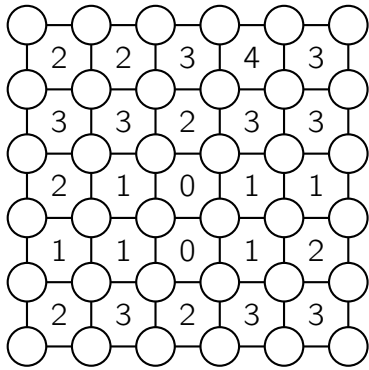

Squaro 22 \*

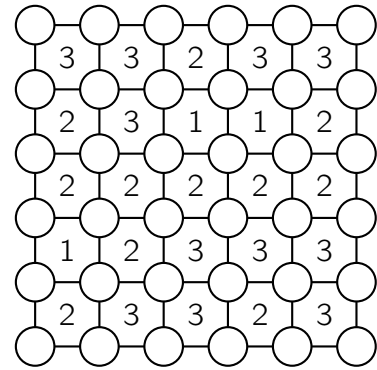

Squaro 23

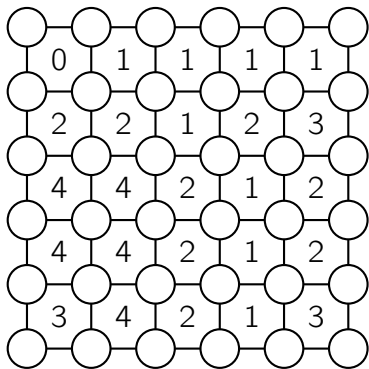

Squaro 23 \*

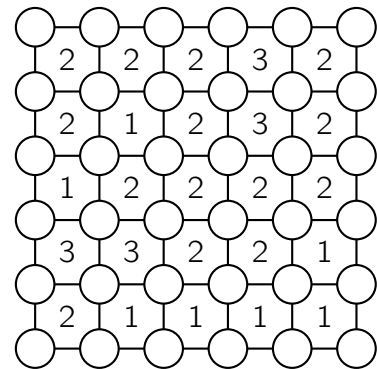

Squaro 24

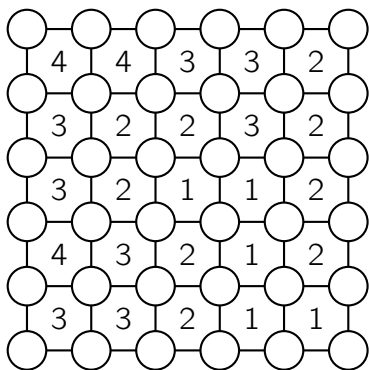

Squaro 24 \*

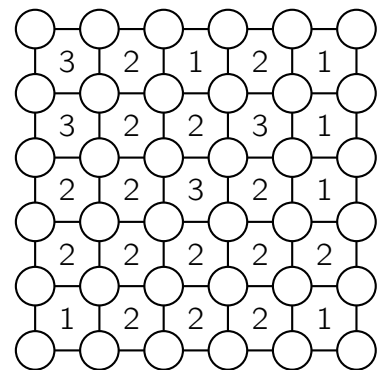

Participant .....

Classe ..... 2024-2025

Participant .....

Classe ..... 2024-2025

**Tentes 21**

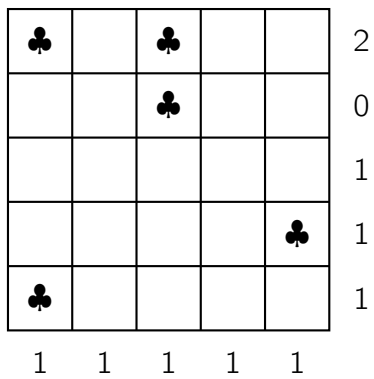

**Tentes 21 \***

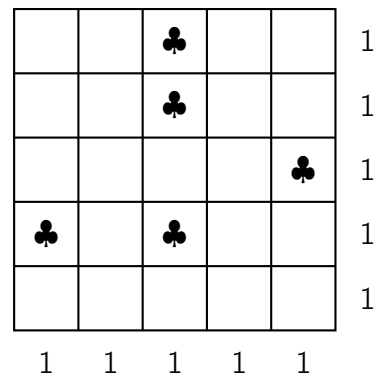

**Tentes 22**

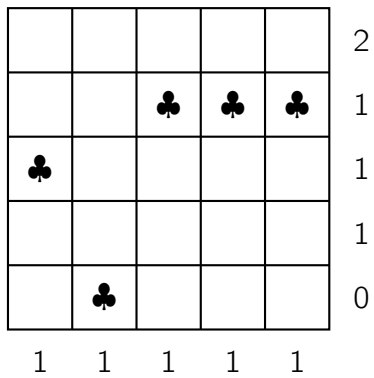

**Tentes 22 \***

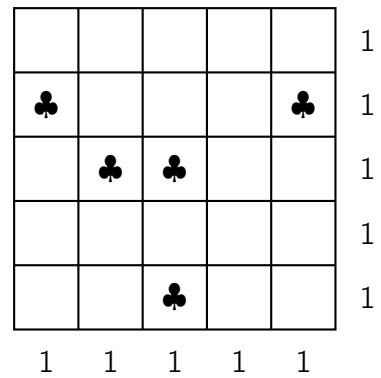

**Tentes 23**

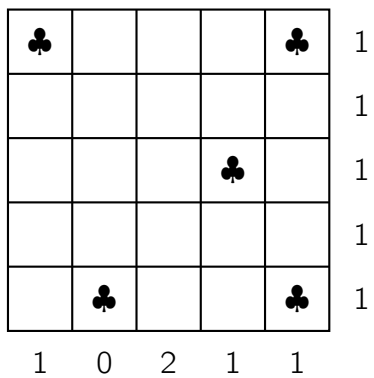

**Tentes 23 \***

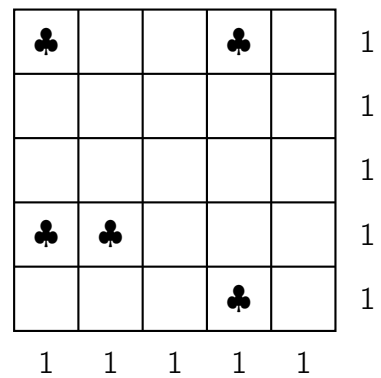

**Tentes 24**

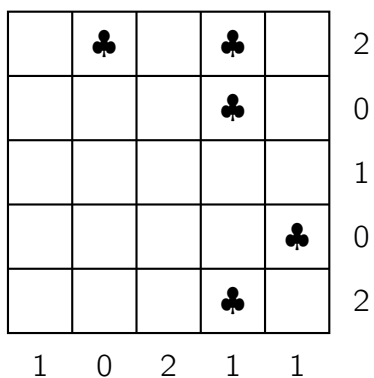

**Tentes 24 \***

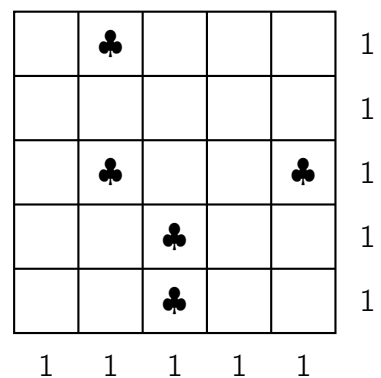

Participant .....

Classe ..... 2024-2025

Participant .....

Classe ..... 2024-2025

**Tracks 21**

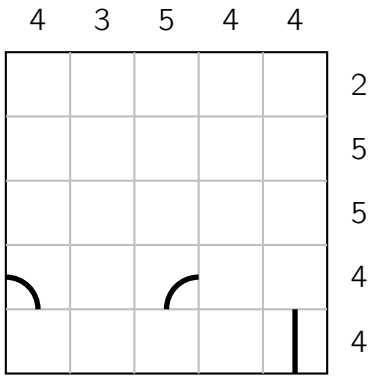

**Tracks 21 \***

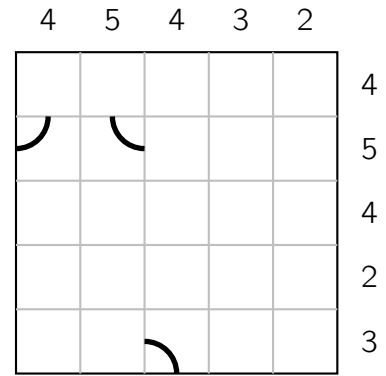

**Tracks 22**

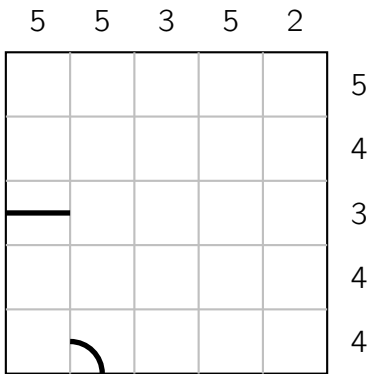

**Tracks 22 \***

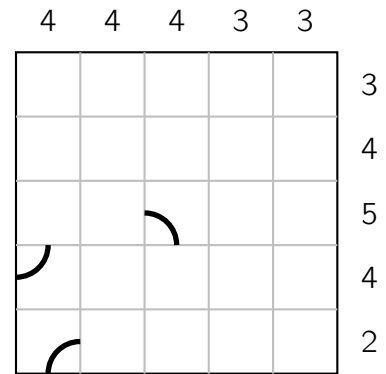

**Tracks 23**

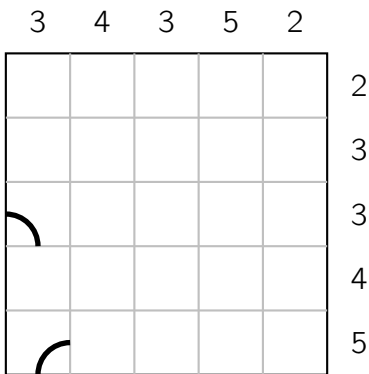

**Tracks 23 \***

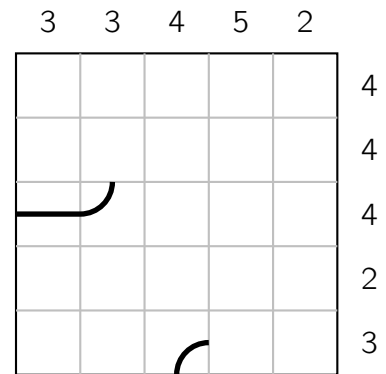

**Tracks 24**

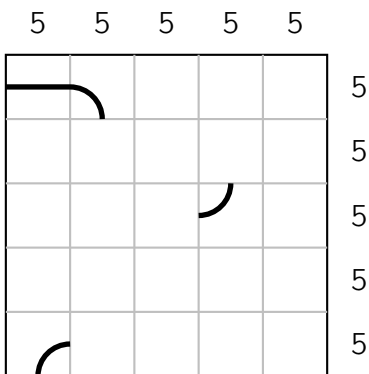

**Tracks 24 \***

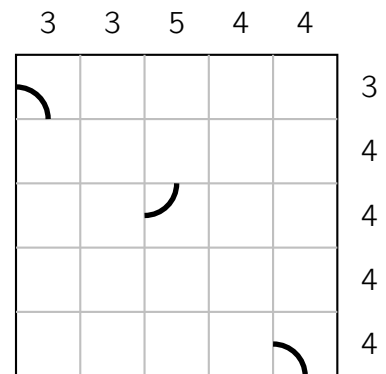

Participant .....

Classe ..... 2024-2025

Participant .....

Classe ..... 2024-2025



**Corrigé 21**

0	1	0	1	1	0
1	0	1	0	0	1
1	0	0	1	1	0
0	1	1	0	1	0
0	1	1	0	0	1
1	0	0	1	0	1

**Corrigé 21 \***

0	1	0	1	1	0
0	1	1	0	0	1
1	0	1	1	0	0
0	1	0	0	1	1
1	0	1	0	1	0
1	0	0	1	0	1

**Corrigé 22**

1	0	1	0	1	0
1	0	0	1	0	1
0	1	0	1	1	0
0	1	1	0	0	1
1	0	1	1	0	0
0	1	0	0	1	1

**Corrigé 22 \***

1	0	1	0	0	1
0	1	0	0	1	1
1	1	0	1	0	0
0	0	1	0	1	1
0	1	0	1	1	0
1	0	1	1	0	0

**Corrigé 23**

0	1	1	0	0	1
0	1	1	0	1	0
1	0	0	1	0	1
0	0	1	1	0	1
1	1	0	0	1	0
1	0	0	1	1	0

**Corrigé 23 \***

1	0	1	1	0	0
0	1	0	0	1	1
1	0	0	1	1	0
0	0	1	1	0	1
1	1	0	0	1	0
0	1	1	0	0	1

**Corrigé 24**

1	0	1	0	1	0
0	1	0	1	1	0
1	0	1	0	0	1
0	0	1	1	0	1
1	1	0	0	1	0
0	1	0	1	0	1

**Corrigé 24 \***

0	1	1	0	0	1
0	1	0	1	1	0
1	0	0	1	0	1
0	0	1	0	1	1
1	1	0	0	1	0
1	0	1	1	0	0

Corrigé 21

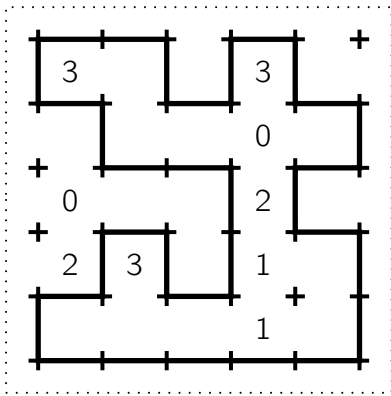

Corrigé 21 \*

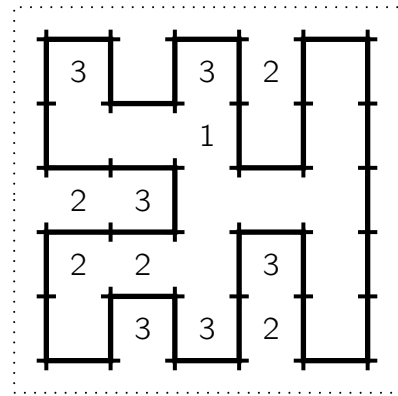

Corrigé 22

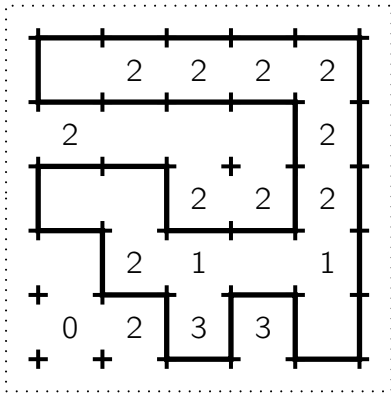

Corrigé 22 \*

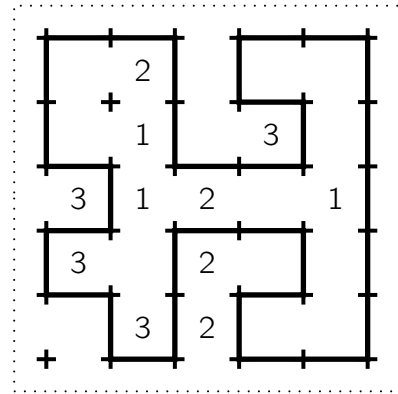

Corrigé 23

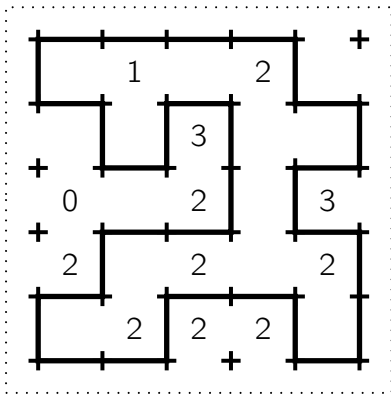

Corrigé 23 \*

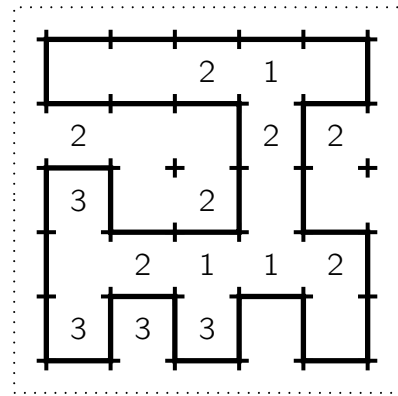

Corrigé 24

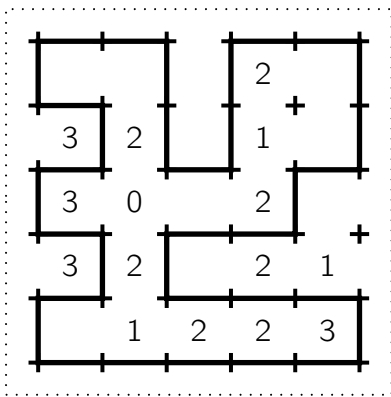

Corrigé 24 \*

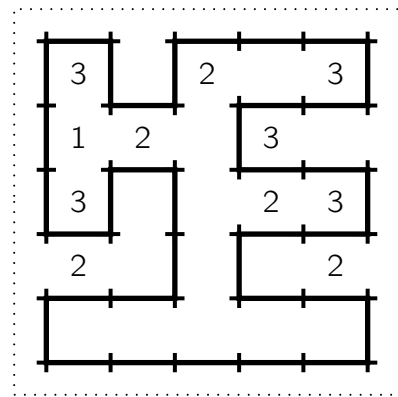

### Corrigé 21

1	1	0	0	3
1	1	3	2	2
0	2	2	2	0
1	3	3	3	0

0·0	0·1	0·2	0·3	1·1
1·2	1·3	2·2	2·3	3·3

### Corrigé 22

3	3	3	2	1
0	2	0	1	1
3	2	0	2	2
0	1	1	3	0

0·0	0·1	0·2	0·3	1·1
1·2	1·3	2·2	2·3	3·3

### Corrigé 23

0	1	3	1	0
2	1	3	2	2
2	3	1	0	1
0	3	3	0	2

0·0	0·1	0·2	0·3	1·1
1·2	1·3	2·2	2·3	3·3

### Corrigé 24

0	3	2	0	1
1	1	1	2	2
2	0	3	0	0
1	3	3	3	2

0·0	0·1	0·2	0·3	1·1
1·2	1·3	2·2	2·3	3·3

### Corrigé 21 \*

3	2	3	1	2
2	0	0	0	1
2	3	3	2	0
1	1	3	1	0

0·0	0·1	0·2	0·3	1·1
1·2	1·3	2·2	2·3	3·3

### Corrigé 22 \*

3	2	1	1	2
1	2	0	1	0
3	2	0	1	3
2	0	3	0	3

0·0	0·1	0·2	0·3	1·1
1·2	1·3	2·2	2·3	3·3

### Corrigé 23 \*

2	2	0	1	1
3	3	0	0	2
1	3	0	0	2
3	2	1	1	3

0·0	0·1	0·2	0·3	1·1
1·2	1·3	2·2	2·3	3·3

### Corrigé 24 \*

2	2	3	3	3
2	0	0	1	0
3	1	0	2	3
0	1	1	2	1

0·0	0·1	0·2	0·3	1·1
1·2	1·3	2·2	2·3	3·3

Corrigé 21

	1	2	2	4	
1→	4	3	2	1	←4
2→	3	4	1	2	←2
3→	1	2	4	3	←2
3→	2	1	3	4	←1
	3	3	2	1	

Corrigé 21 \*

			2		
3→	2	3	1	4	←
3→	1	2	4	3	←
→	4	1	3	2	←3
→	3	4	2	1	←
	1	3			

Corrigé 22

	2	4	1	3	
2→	3	1	4	2	←2
1→	4	2	1	3	←2
3→	1	3	2	4	←1
2→	2	4	3	1	←3
	2	1	2	2	

Corrigé 22 \*

	3	1		2	
→	2	4	3	1	←
→	3	1	2	4	←
→	4	2	1	3	←
→	1	3	4	2	←
	2				

Corrigé 23

	2	1	3	3	
2→	3	4	1	2	←2
1→	4	3	2	1	←4
2→	2	1	4	3	←2
4→	1	2	3	4	←1
	3	3	2	1	

Corrigé 23 \*

→	4	3	1	2	←3
2→	2	1	4	3	←
→	3	4	2	1	←3
→	1	2	3	4	←
	3			1	

Corrigé 24

	2	3	2	1	
4→	1	2	3	4	←1
1→	4	3	2	1	←4
2→	3	1	4	2	←2
2→	2	4	1	3	←2
	3	1	2	2	

Corrigé 24 \*

		1		2	
→	1	4	2	3	←
→	4	1	3	2	←
→	3	2	1	4	←
→	2	3	4	1	←
	2			2	

Corrigé 21

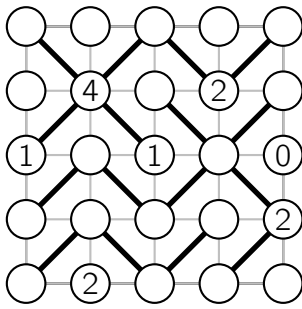

Corrigé 21 \*

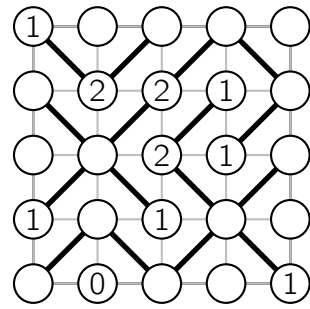

Corrigé 22

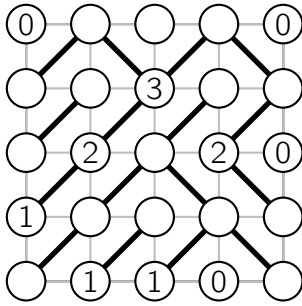

Corrigé 22 \*

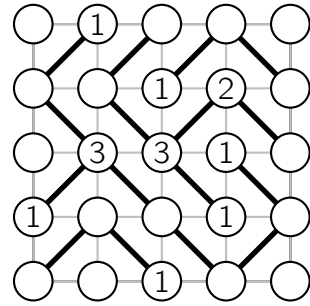

Corrigé 23

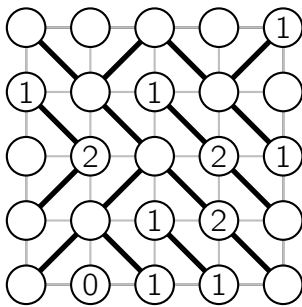

Corrigé 23 \*

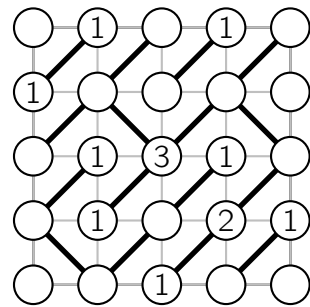

Corrigé 24

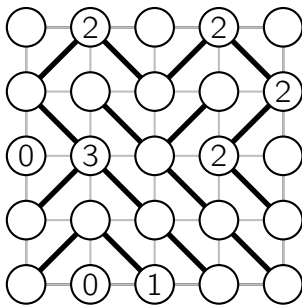

Corrigé 24 \*

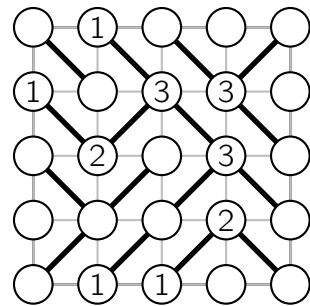

Corrigé 21

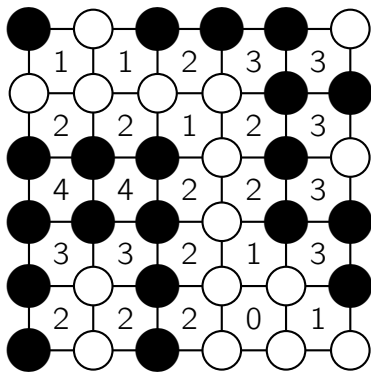

Corrigé 21 \*

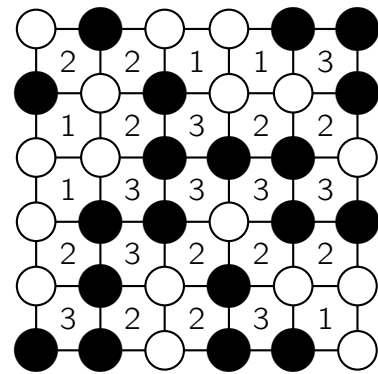

Corrigé 22

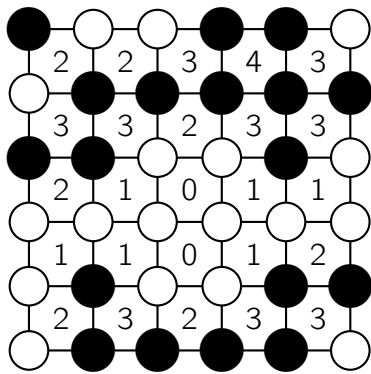

Corrigé 22 \*

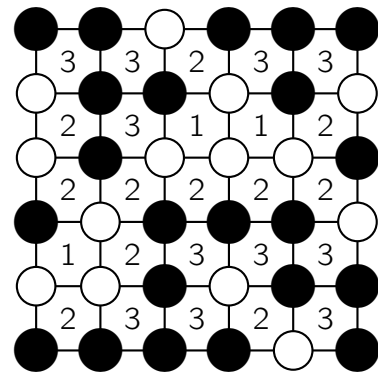

Corrigé 23

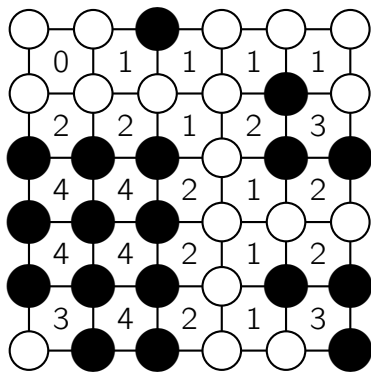

Corrigé 23 \*

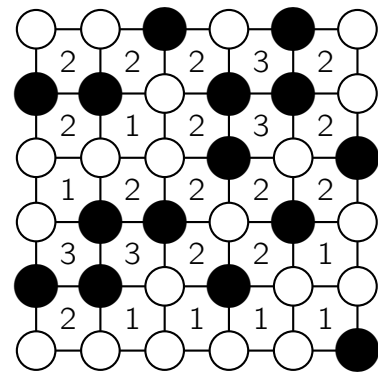

Corrigé 24

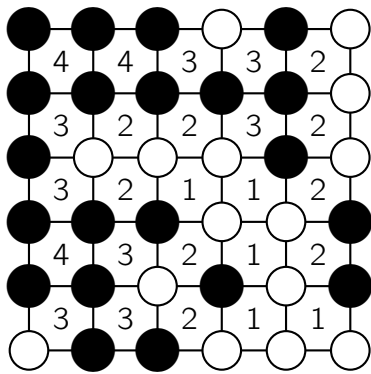

Corrigé 24 \*

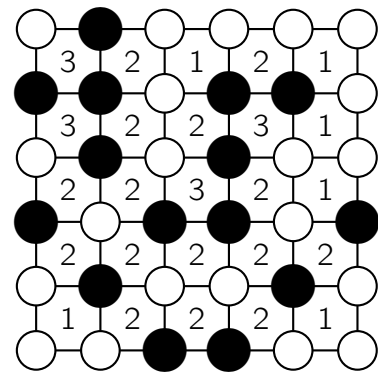

Corrigé 21

♣	△	♣	△		2
		♣			0
		△			1
△				♣	1
♣				△	1
1	1	1	1	1	

Corrigé 21 \*

	△	♣			1
		♣	△		1
△				♣	1
♣		♣		△	1
		△			1
1	1	1	1	1	

Corrigé 22

		△		△	2
△		♣	♣	♣	1
♣			△		1
	△				1
	♣				0
1	1	1	1	1	

Corrigé 22 \*

△					1
♣		△		♣	1
	♣	♣		△	1
	△				1
		♣	△		1
1	1	1	1	1	

Corrigé 23

♣			△	♣	1
△					1
		△	♣		1
				△	1
	♣	△		♣	1
1	0	2	1	1	

Corrigé 23 \*

♣	△		♣		1
			△		1
△					1
♣	♣	△			1
			♣	△	1
1	1	1	1	1	

Corrigé 24

△	♣	△	♣		2
			♣		0
			△		1
				♣	0
		△	♣	△	2
1	0	2	1	1	

Corrigé 24 \*

	♣	△			1
				△	1
△	♣			♣	1
		♣	△		1
	△	♣			1
1	1	1	1	1	

