

**Binaro 17**

		1			1
1	1				
1				0	
		1			
	0				1
	0				

**Binaro 17 \***

		0			1
		0			
					0
1		1			1
1				1	

**Binaro 18**

	1				
0				0	
				0	0
		0			
			1		
	1			0	

**Binaro 18 \***

	1				
0					
				1	
	0		0		0
0					0

**Binaro 19**

		0	0		
	0				
	0		0		0
					0
1			0	0	

**Binaro 19 \***

1			0		1
	1	1			
0					0
			0	1	

**Binaro 20**

	1			1	
			0		
					0
	0	0			0
	0	0			

**Binaro 20 \***

				0	
					1
			1		
0				0	
	0		1		1

Participant .....

Classe ..... 2024-2025

Participant .....

Classe ..... 2024-2025

**Clôtures 17**

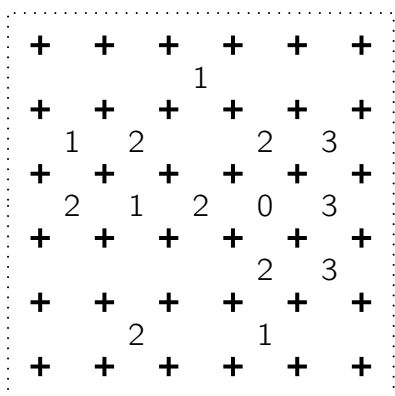

**Clôtures 17 \***

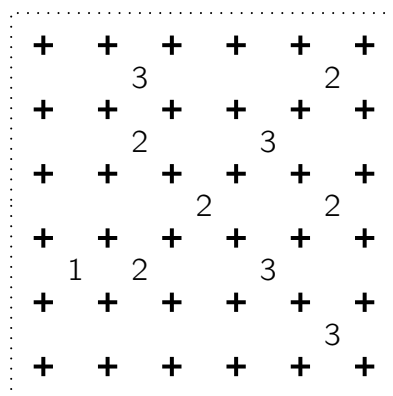

**Clôtures 18**

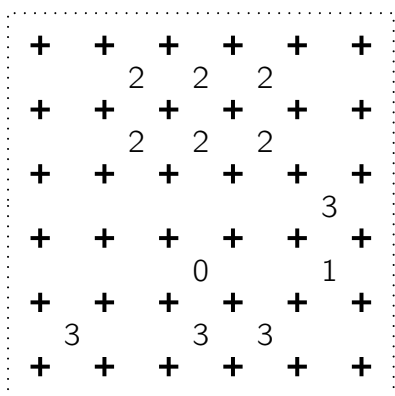

**Clôtures 18 \***

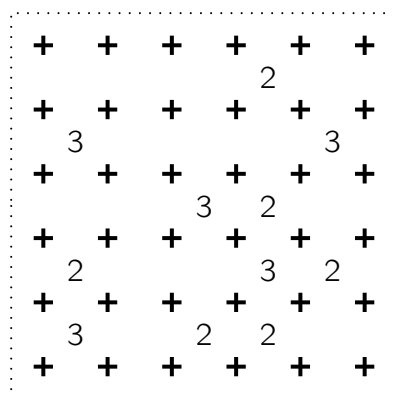

**Clôtures 19**

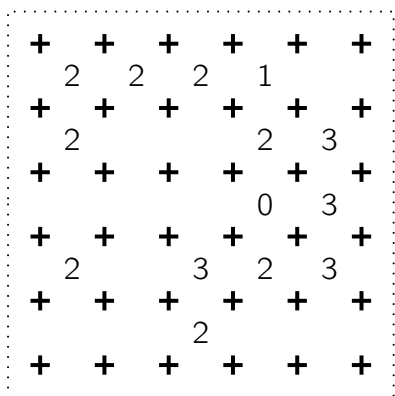

**Clôtures 19 \***

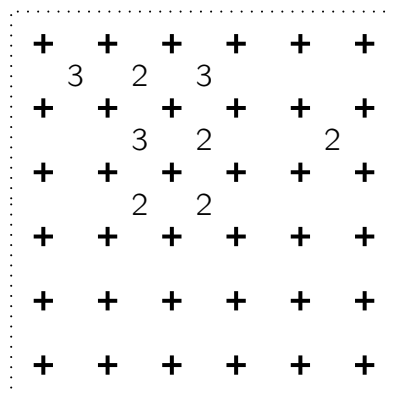

**Clôtures 20**

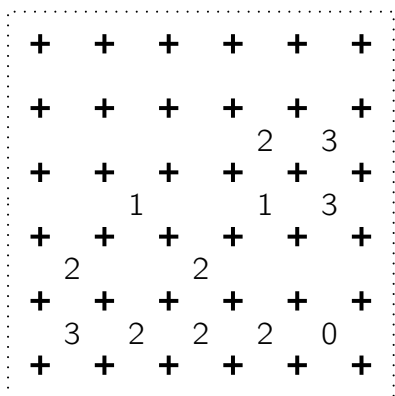

**Clôtures 20 \***

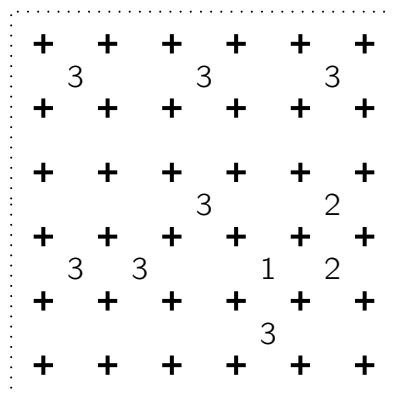

Participant .....

Classe ..... 2024-2025

Participant .....

Classe ..... 2024-2025

### Dominos 17

1	3	0	2	1
1	2	3	3	2
0	3	1	2	2
3	0	0	0	1

0·0	0·1	0·2	0·3	1·1
1·2	1·3	2·2	2·3	3·3

### Dominos 18

0	0	3	2	3
0	3	3	0	0
1	2	3	1	1
1	2	1	2	2

0·0	0·1	0·2	0·3	1·1
1·2	1·3	2·2	2·3	3·3

### Dominos 19

1	2	1	2	0
1	3	1	3	0
0	3	2	0	3
2	2	3	1	0

0·0	0·1	0·2	0·3	1·1
1·2	1·3	2·2	2·3	3·3

### Dominos 20

2	3	3	1	0
0	2	1	3	0
3	2	1	2	1
1	2	3	0	0

0·0	0·1	0·2	0·3	1·1
1·2	1·3	2·2	2·3	3·3

### Dominos 17 \*

3	0	0	3	1
2	2	2	2	0
1	1	0	1	0
3	3	2	1	3

0·0	0·1	0·2	0·3	1·1
1·2	1·3	2·2	2·3	3·3

### Dominos 18 \*

1	1	0	1	2
3	2	2	0	0
3	1	3	3	0
3	0	2	2	1

0·0	0·1	0·2	0·3	1·1
1·2	1·3	2·2	2·3	3·3

### Dominos 19 \*

1	3	2	0	0
1	0	3	2	2
0	3	3	2	0
2	1	1	1	3

0·0	0·1	0·2	0·3	1·1
1·2	1·3	2·2	2·3	3·3

### Dominos 20 \*

3	3	2	3	2
1	2	2	1	0
3	0	1	2	0
3	0	1	0	1

0·0	0·1	0·2	0·3	1·1
1·2	1·3	2·2	2·3	3·3

Participant .....

Classe ..... 2024-2025

Participant .....

Classe ..... 2024-2025

**Gratte-ciel 17**

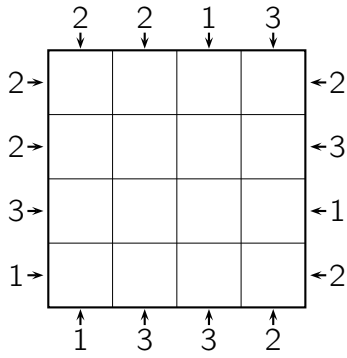

**Gratte-ciel 17 \***

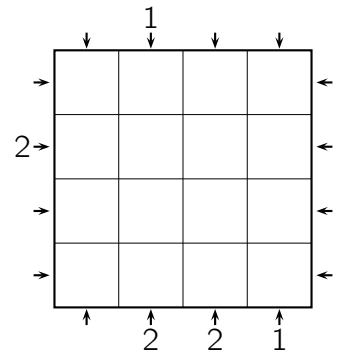

**Gratte-ciel 18**

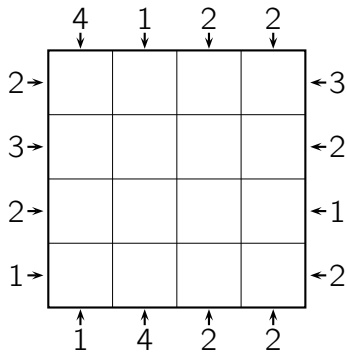

**Gratte-ciel 18 \***

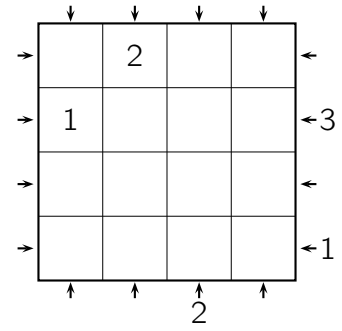

**Gratte-ciel 19**

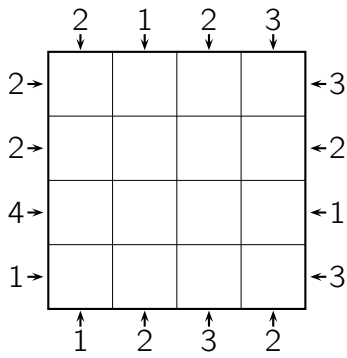

**Gratte-ciel 19 \***

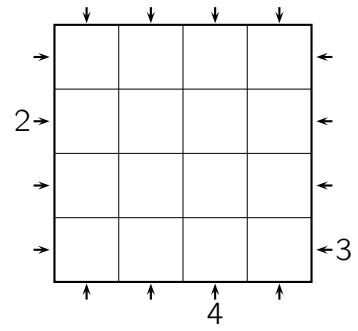

**Gratte-ciel 20**

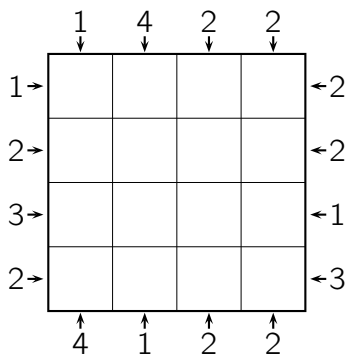

**Gratte-ciel 20 \***

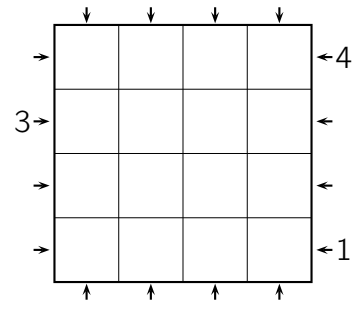

Participant .....

Classe ..... 2024-2025

Participant .....

Classe ..... 2024-2025

**Slants 17**

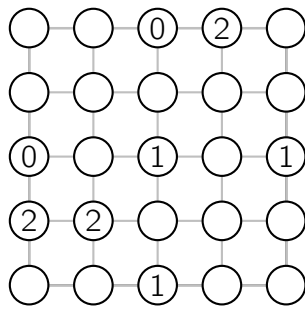

**Slants 17 \***

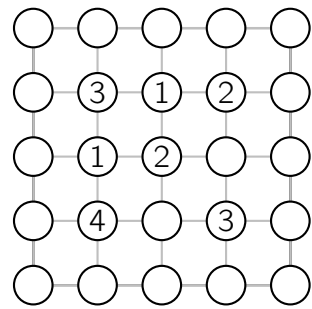

**Slants 18**

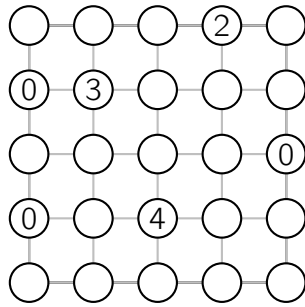

**Slants 18 \***

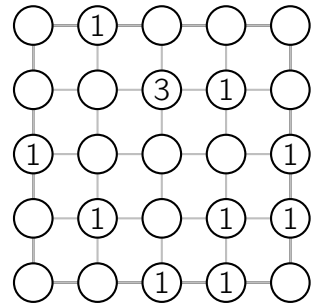

**Slants 19**

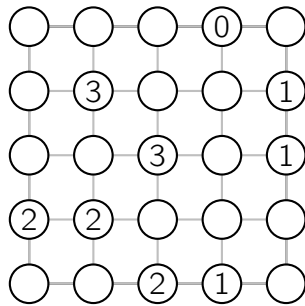

**Slants 19 \***

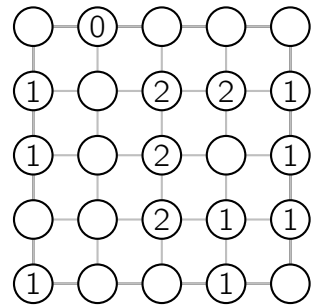

**Slants 20**

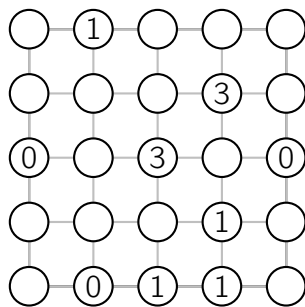

**Slants 20 \***

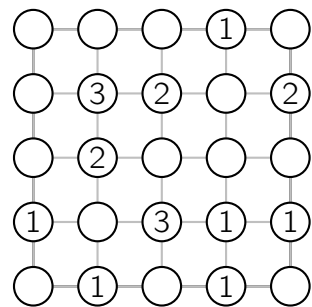

Participant .....

Classe ..... 2024-2025

Participant .....

Classe ..... 2024-2025

Squaro 17

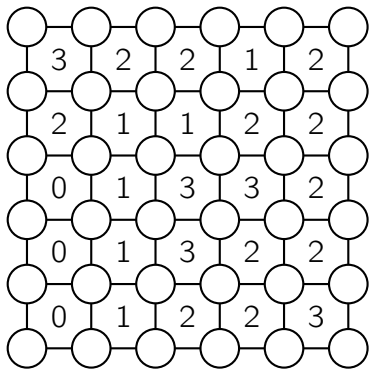

Squaro 17 \*

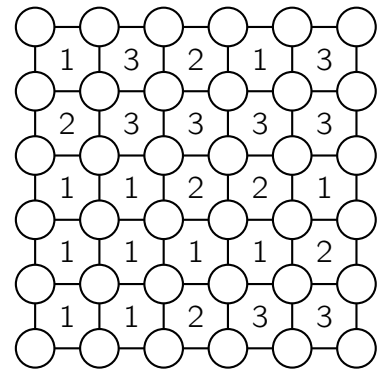

Squaro 18

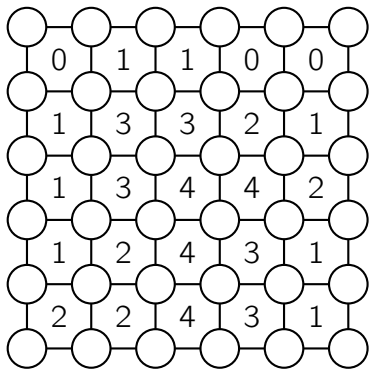

Squaro 18 \*

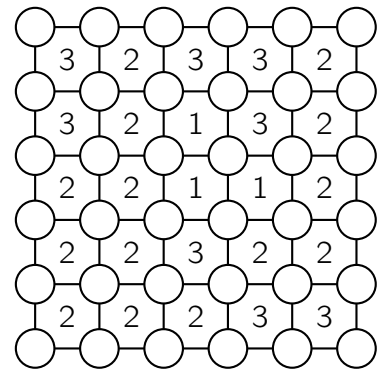

Squaro 19

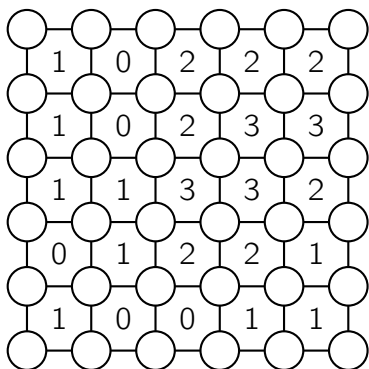

Squaro 19 \*

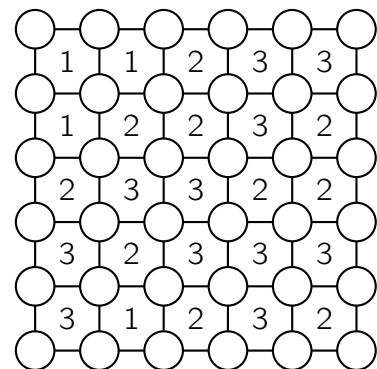

Squaro 20

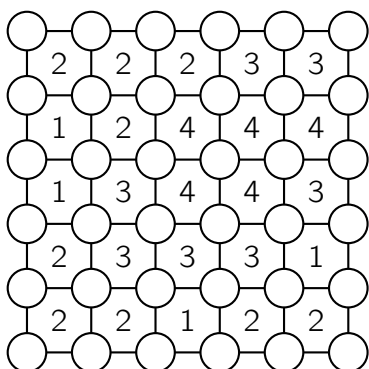

Squaro 20 \*

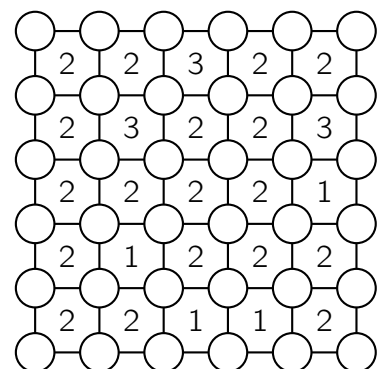

Participant .....

Classe ..... 2024-2025

Participant .....

Classe ..... 2024-2025

**Tentes 17**

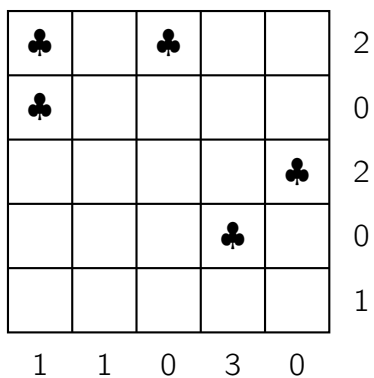

**Tentes 17 \***

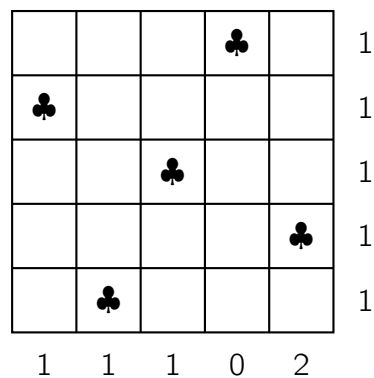

**Tentes 18**

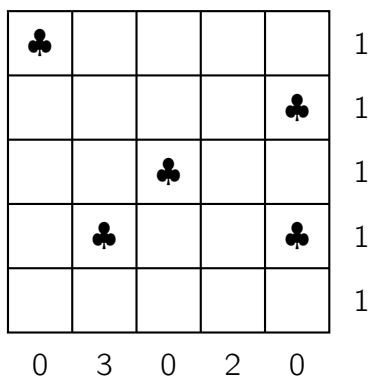

**Tentes 18 \***

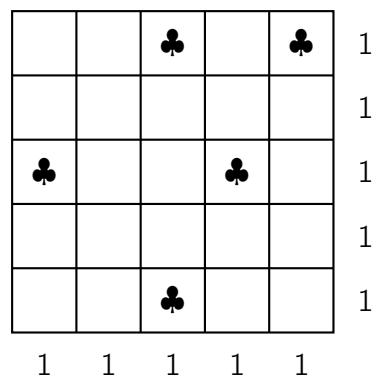

**Tentes 19**

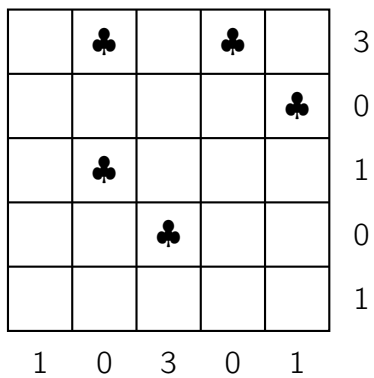

**Tentes 19 \***

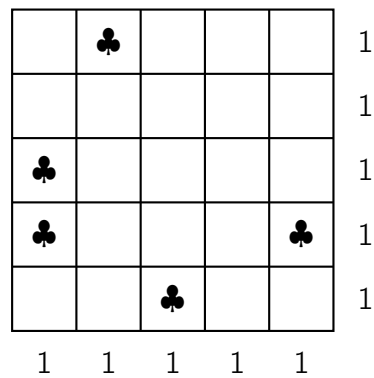

**Tentes 20**

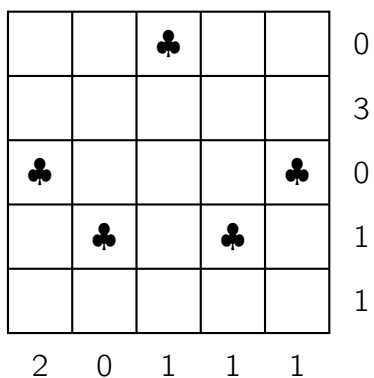

**Tentes 20 \***

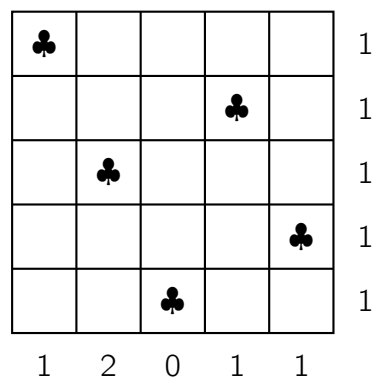

Participant .....

Classe ..... 2024-2025

Participant .....

Classe ..... 2024-2025

**Tracks 17**

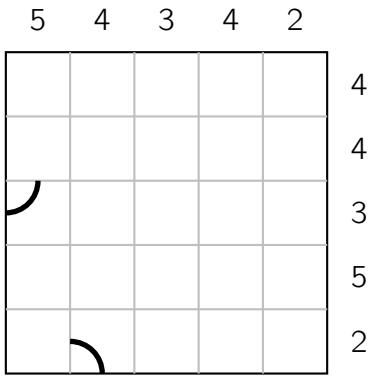

**Tracks 17 \***

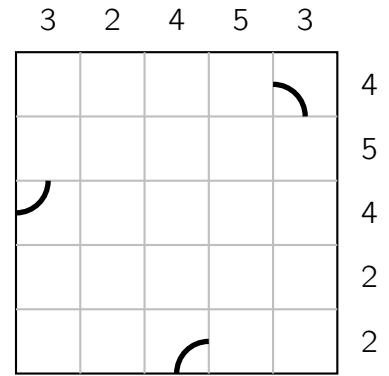

**Tracks 18**

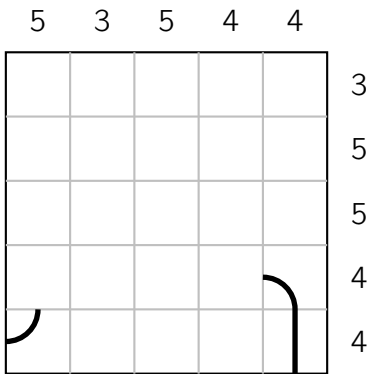

**Tracks 18 \***

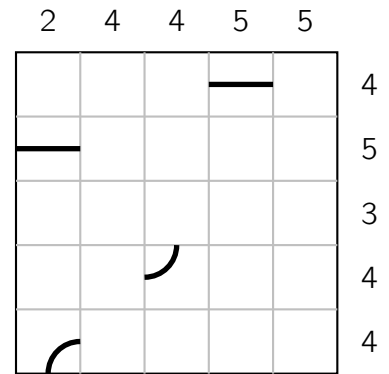

**Tracks 19**

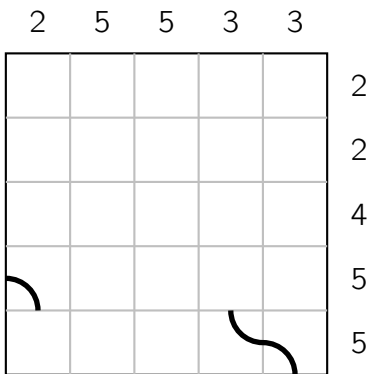

**Tracks 19 \***

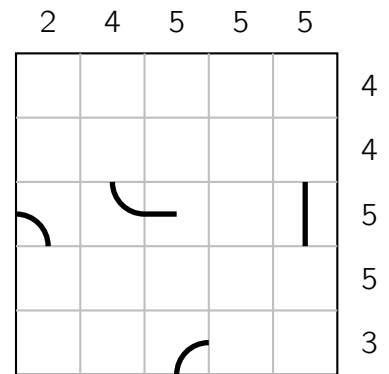

**Tracks 20**

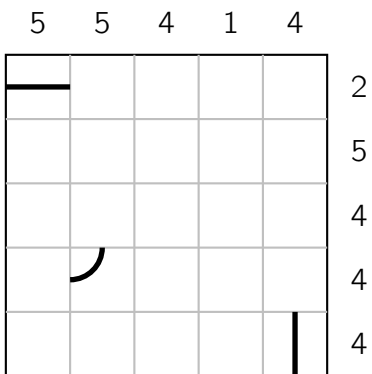

**Tracks 20 \***

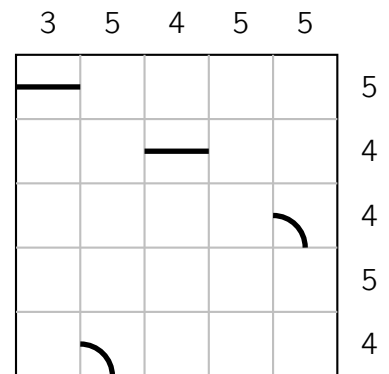

Participant .....

Classe ..... 2024-2025

Participant .....

Classe ..... 2024-2025



**Corrigé 17**

0	1	1	0	0	1
1	1	0	0	1	0
1	0	0	1	0	1
0	1	1	0	1	0
0	0	1	1	0	1
1	0	0	1	1	0

**Corrigé 17 \***

0	1	0	1	0	1
1	0	0	1	0	1
0	1	1	0	1	0
0	1	0	1	1	0
1	0	1	0	0	1
1	0	1	0	1	0

**Corrigé 18**

1	1	0	0	1	0
0	0	1	1	0	1
1	0	1	1	0	0
0	1	0	0	1	1
1	0	0	1	1	0
0	1	1	0	0	1

**Corrigé 18 \***

1	1	0	1	0	0
0	0	1	1	0	1
0	1	0	0	1	1
1	0	1	0	1	0
1	0	0	1	0	1
0	1	1	0	1	0

**Corrigé 19**

1	1	0	0	1	0
0	0	1	1	0	1
1	0	1	0	1	0
0	1	0	1	1	0
0	1	0	1	0	1
1	0	1	0	0	1

**Corrigé 19 \***

0	1	0	1	0	1
1	0	1	0	0	1
1	0	0	1	1	0
0	1	1	0	0	1
0	1	0	1	1	0
1	0	1	0	1	0

**Corrigé 20**

0	1	1	0	0	1
0	1	0	1	1	0
1	0	1	0	0	1
0	1	1	0	1	0
1	0	0	1	1	0
1	0	0	1	0	1

**Corrigé 20 \***

1	1	0	0	1	0
1	0	1	1	0	0
0	1	0	0	1	1
1	0	0	1	1	0
0	1	1	0	0	1
0	0	1	1	0	1

Corrigé 17

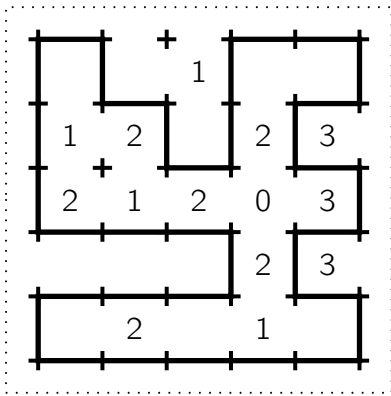

Corrigé 17 \*

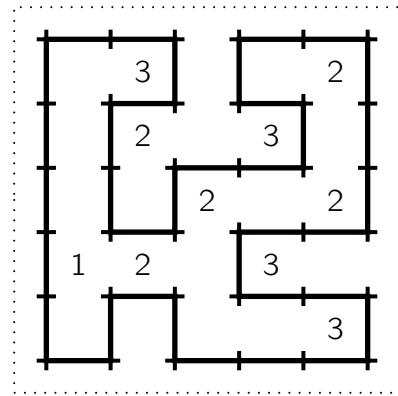

Corrigé 18

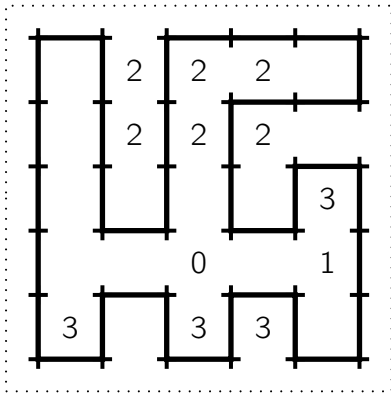

Corrigé 18 \*

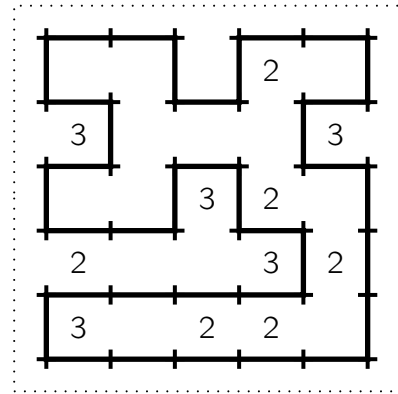

Corrigé 19

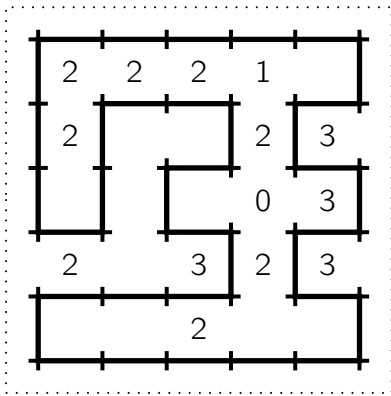

Corrigé 19 \*

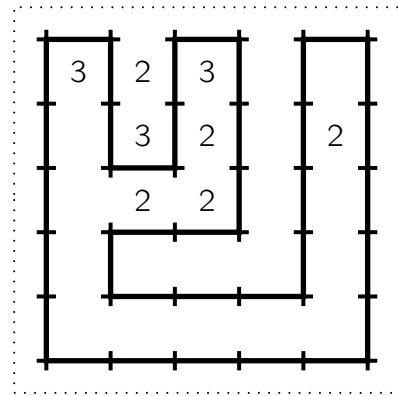

Corrigé 20

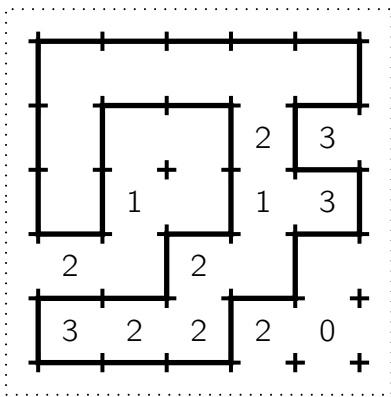

Corrigé 20 \*

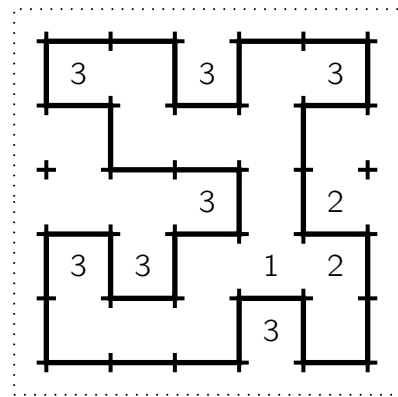

### Corrigé 17

1	3	0	2	1
1	2	3	3	2
0	3	1	2	2
3	0	0	0	1

0·0	0·1	0·2	0·3	1·1
1·2	1·3	2·2	2·3	3·3

### Corrigé 18

0	0	3	2	3
0	3	3	0	0
1	2	3	1	1
1	2	1	2	2

0·0	0·1	0·2	0·3	1·1
1·2	1·3	2·2	2·3	3·3

### Corrigé 19

1	2	1	2	0
1	3	1	3	0
0	3	2	0	3
2	2	3	1	0

0·0	0·1	0·2	0·3	1·1
1·2	1·3	2·2	2·3	3·3

### Corrigé 20

2	3	3	1	0
0	2	1	3	0
3	2	1	2	1
1	2	3	0	0

0·0	0·1	0·2	0·3	1·1
1·2	1·3	2·2	2·3	3·3

### Corrigé 17 \*

3	0	0	3	1
2	2	2	2	0
1	1	0	1	0
3	3	2	1	3

0·0	0·1	0·2	0·3	1·1
1·2	1·3	2·2	2·3	3·3

### Corrigé 18 \*

1	1	0	1	2
3	2	2	0	0
3	1	3	3	0
3	0	2	2	1

0·0	0·1	0·2	0·3	1·1
1·2	1·3	2·2	2·3	3·3

### Corrigé 19 \*

1	3	2	0	0
1	0	3	2	2
0	3	3	2	0
2	1	1	1	3

0·0	0·1	0·2	0·3	1·1
1·2	1·3	2·2	2·3	3·3

### Corrigé 20 \*

3	3	2	3	2
1	2	2	1	0
3	0	1	2	0
3	0	1	0	1

0·0	0·1	0·2	0·3	1·1
1·2	1·3	2·2	2·3	3·3

### Corrigé 17

	2	2	1	3	
2→	3	2	4	1	←2
2→	1	4	3	2	←3
3→	2	3	1	4	←1
1→	4	1	2	3	←2
	1	3	3	2	

### Corrigé 17 \*

		1			
→	2	4	3	1	←
2→	3	1	4	2	←
→	4	2	1	3	←
→	1	3	2	4	←
	↑	2	2	1	

### Corrigé 18

	4	1	2	2	
2→	1	4	3	2	←3
3→	2	3	4	1	←2
2→	3	2	1	4	←1
1→	4	1	2	3	←2
	1	4	2	2	

### Corrigé 18 \*

	↓	↓	↓	↓	
→	4	2	1	3	←
→	1	4	3	2	←3
→	2	3	4	1	←
→	3	1	2	4	←1
	↑	↑	2	↑	

### Corrigé 19

	2	1	2	3	
2→	3	4	2	1	←3
2→	2	1	4	3	←2
4→	1	2	3	4	←1
1→	4	3	1	2	←3
	1	2	3	2	

### Corrigé 19 \*

	↓	↓	↓	↓	
→	1	2	4	3	←
2→	2	4	3	1	←
→	3	1	2	4	←
→	4	3	1	2	←3
	↑	↑	4	↑	

### Corrigé 20

	1	4	2	2	
1→	4	1	2	3	←2
2→	3	2	4	1	←2
3→	2	3	1	4	←1
2→	1	4	3	2	←3
	4	1	2	2	

### Corrigé 20 \*

	↓	↓	↓	↓	
→	4	3	2	1	←4
3→	1	2	4	3	←
→	3	4	1	2	←
→	2	1	3	4	←1
	↑	↑	↑	↑	

Corrigé 17

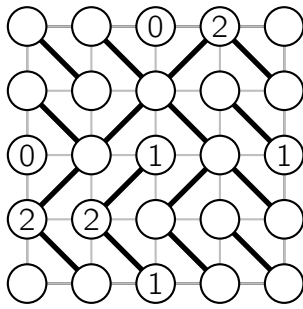

Corrigé 17 \*

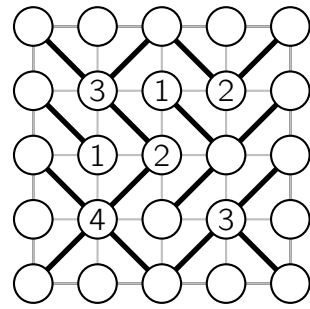

Corrigé 18

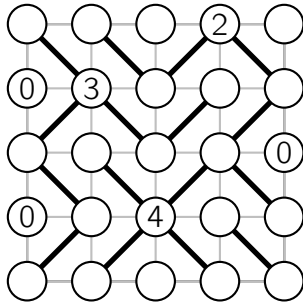

Corrigé 18 \*

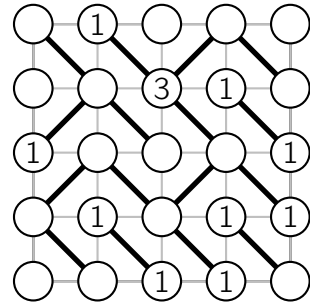

Corrigé 19

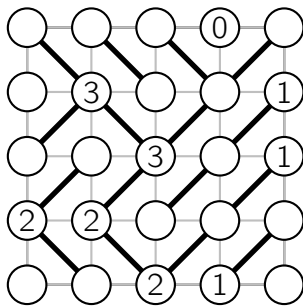

Corrigé 19 \*

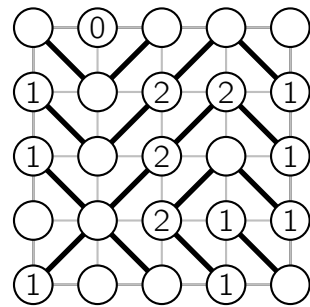

Corrigé 20

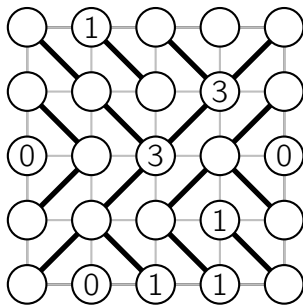

Corrigé 20 \*

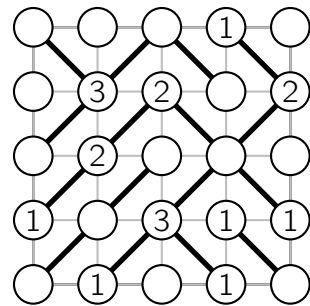

Corrigé 17

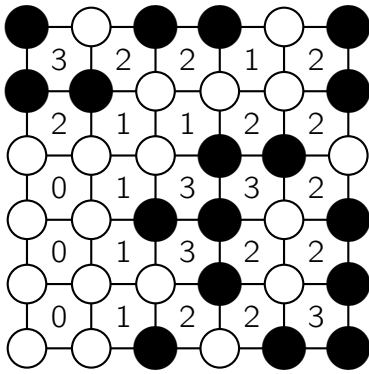

Corrigé 17 \*

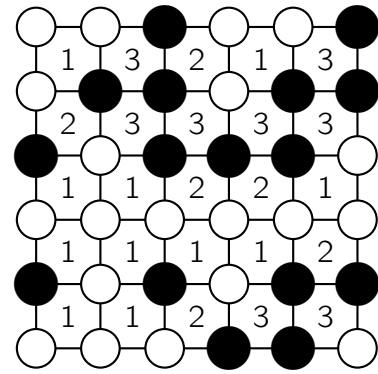

Corrigé 18

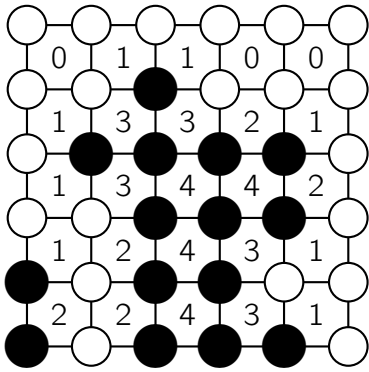

Corrigé 18 \*

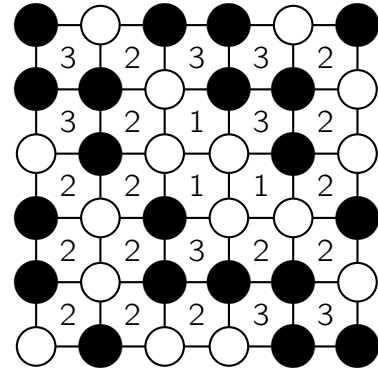

Corrigé 19

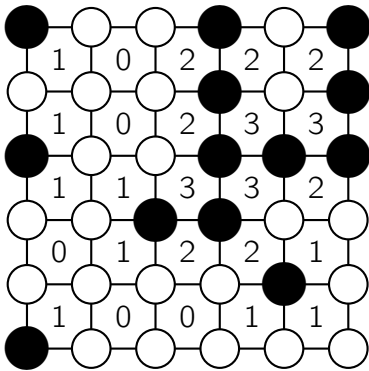

Corrigé 19 \*

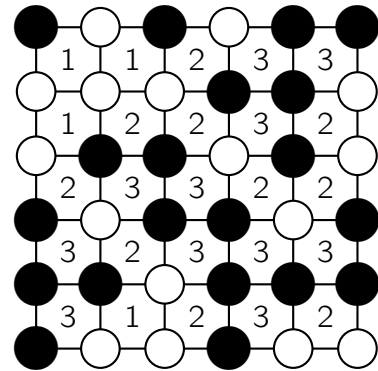

Corrigé 20

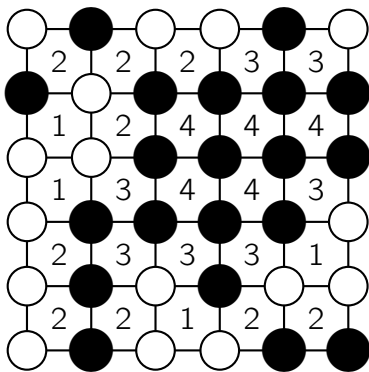

Corrigé 20 \*

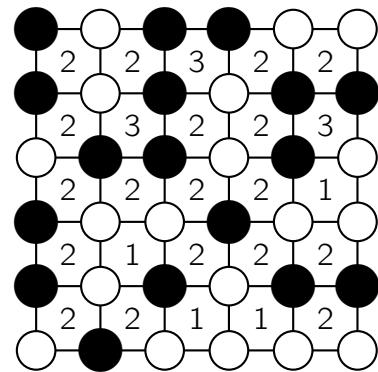

Corrigé 17

♣	△	♣	△		2
♣					0
△			△	♣	2
			♣		0
			△		1
1	1	0	3	0	

Corrigé 17 \*

			♣	△	1
♣	△				1
		♣		△	1
		△		♣	1
△	♣				1
1	1	1	0	2	

Corrigé 18

♣	△				1
			△	♣	1
	△	♣			1
	♣		△	♣	1
	△				1
0	3	0	2	0	

Corrigé 18 \*

	△	♣		♣	1
				△	1
♣		△	♣		1
△					1
		♣	△		1
1	1	1	1	1	

Corrigé 19

△	♣	△	♣	△	3
				♣	0
	♣	△			1
		♣			0
		△			1
1	0	3	0	1	

Corrigé 19 \*

	♣	△			1
△					1
♣				△	1
♣	△			♣	1
		♣	△		1
1	1	1	1	1	

Corrigé 20

		♣			0
△		△		△	3
♣				♣	0
△	♣		♣		1
			△		1
2	0	1	1	1	

Corrigé 20 \*

♣	△				1
			♣	△	1
△	♣				1
			△	♣	1
	△	♣			1
1	2	0	1	1	

Corrigé 17

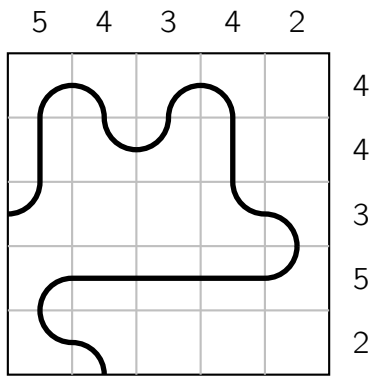

Corrigé 17 \*

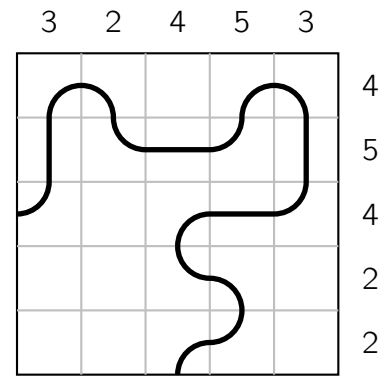

Corrigé 18

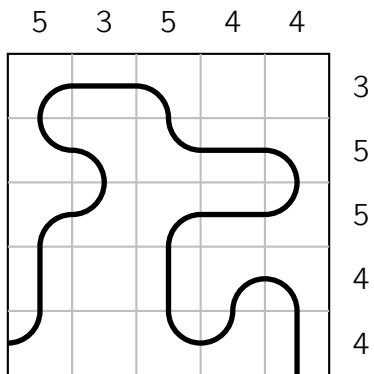

Corrigé 18 \*

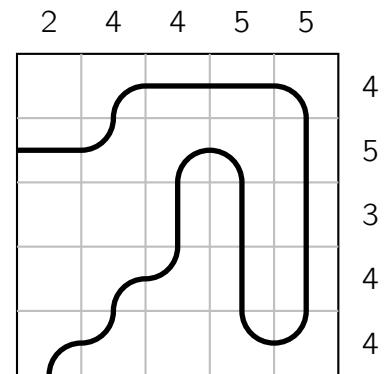

Corrigé 19

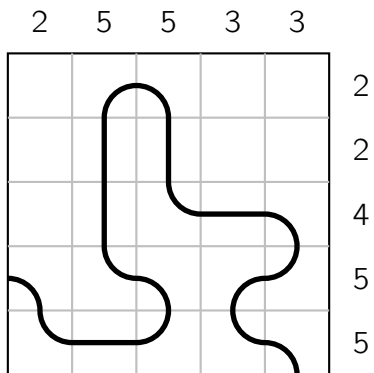

Corrigé 19 \*

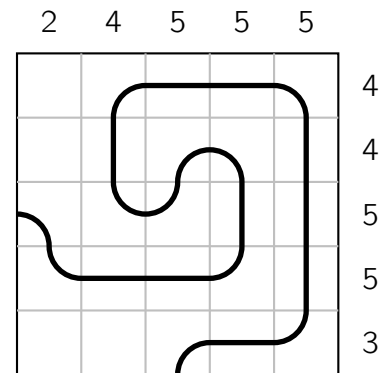

Corrigé 20

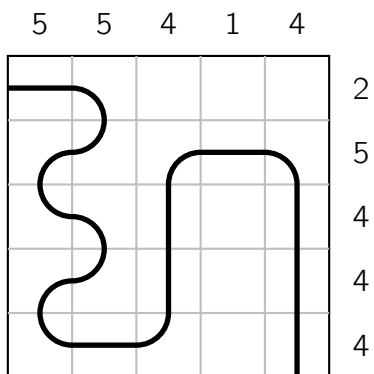

Corrigé 20 \*

