

Binaro 13

					1
	0			1	
1	0			0	
1					1
1				0	

Binaro 13 *

			0	1	
1			0	0	
1					
		0			
1				1	

Binaro 14

	1	0			
					1
	1	1			
			0		
	1			1	
				1	0

Binaro 14 *

1				1	
				0	
	1	0			
		0			
			0	0	
	0				0

Binaro 15

		1			0
				1	
0		1			
			1	1	
		1		1	

Binaro 15 *

		1	0		
					1
				1	1
		1		1	1

Binaro 16

		0			
1					1
	1			0	
		0			1
1					
				1	

Binaro 16 *

	1				
0	1			0	
				1	
			1		0
			1		0
				0	

Participant

Classe 2024-2025

Participant

Classe 2024-2025

Clôtures 13

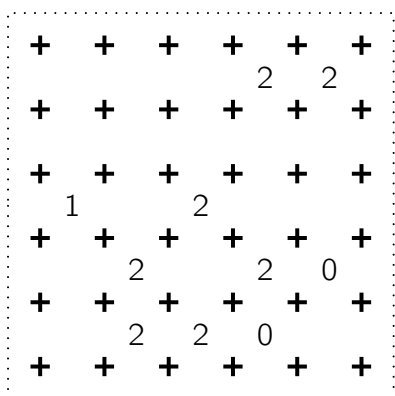

Clôtures 13 *

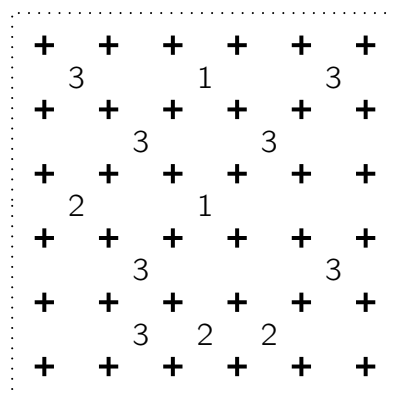

Clôtures 14

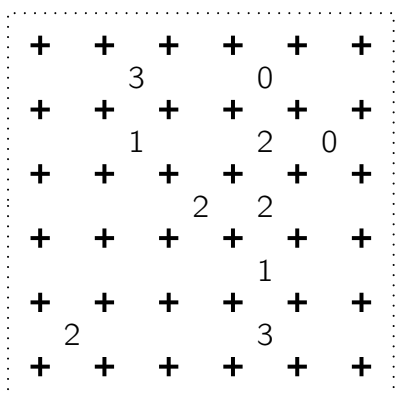

Clôtures 14 *

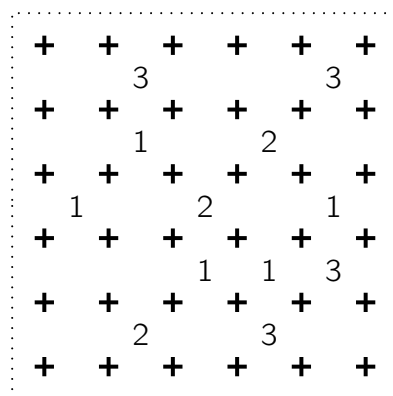

Clôtures 15

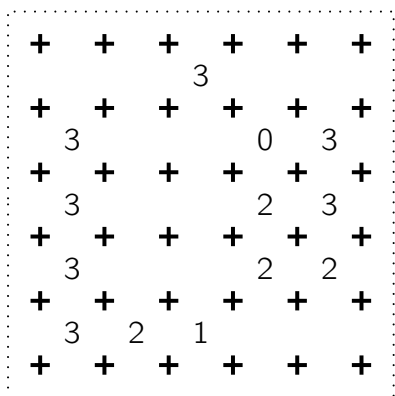

Clôtures 15 *

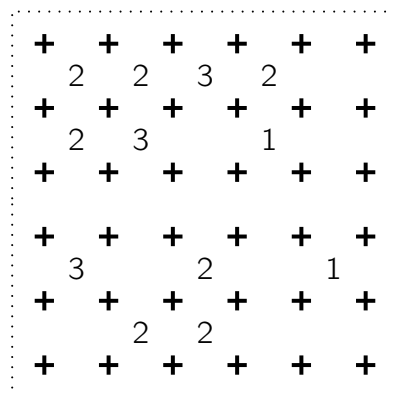

Clôtures 16

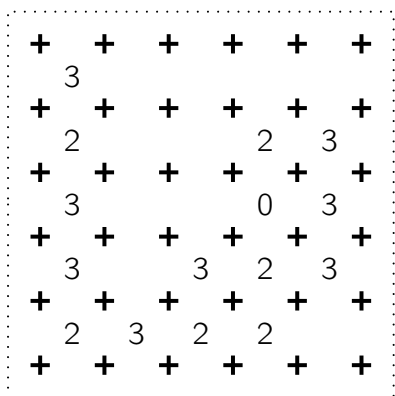

Clôtures 16 *

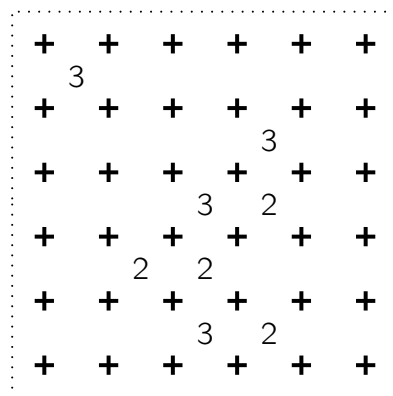

Participant

Classe 2024-2025

Participant

Classe 2024-2025

Dominos 13

0	1	0	3	0
3	2	2	1	2
3	2	1	2	3
1	3	1	0	0

0·0	0·1	0·2	0·3	1·1
1·2	1·3	2·2	2·3	3·3

Dominos 13 *

1	3	3	3	2
1	0	2	1	0
0	2	2	3	0
3	1	1	2	0

0·0	0·1	0·2	0·3	1·1
1·2	1·3	2·2	2·3	3·3

Dominos 14

1	1	0	0	2
1	2	3	3	2
2	0	0	3	2
0	3	3	1	1

0·0	0·1	0·2	0·3	1·1
1·2	1·3	2·2	2·3	3·3

Dominos 14 *

0	1	1	1	2
0	3	3	2	3
2	3	3	2	1
0	0	0	1	2

0·0	0·1	0·2	0·3	1·1
1·2	1·3	2·2	2·3	3·3

Dominos 15

1	1	3	2	3
2	2	0	1	0
2	2	1	3	1
3	3	0	0	0

0·0	0·1	0·2	0·3	1·1
1·2	1·3	2·2	2·3	3·3

Dominos 15 *

1	0	0	2	3
1	1	0	2	1
3	0	3	3	3
0	1	2	2	2

0·0	0·1	0·2	0·3	1·1
1·2	1·3	2·2	2·3	3·3

Dominos 16

0	2	2	2	1
2	3	0	3	3
0	2	0	1	0
1	3	1	1	3

0·0	0·1	0·2	0·3	1·1
1·2	1·3	2·2	2·3	3·3

Dominos 16 *

2	1	1	1	3
2	3	0	1	2
0	1	0	3	2
0	3	3	0	2

0·0	0·1	0·2	0·3	1·1
1·2	1·3	2·2	2·3	3·3

Participant

Classe 2024-2025

Participant

Classe 2024-2025

Gratte-ciel 13

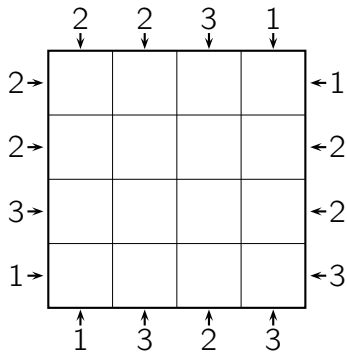

Gratte-ciel 13 *

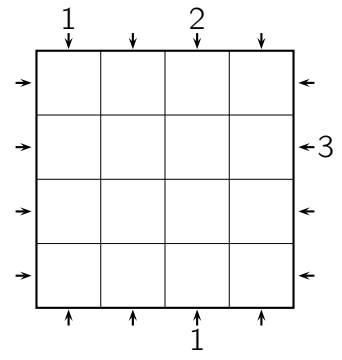

Gratte-ciel 14

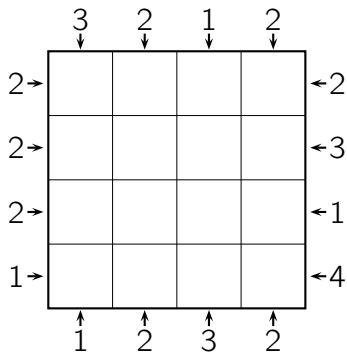

Gratte-ciel 14 *

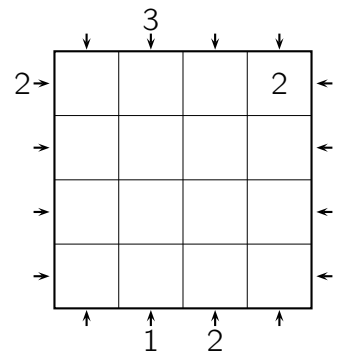

Gratte-ciel 15

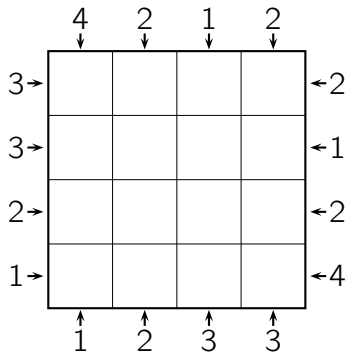

Gratte-ciel 15 *

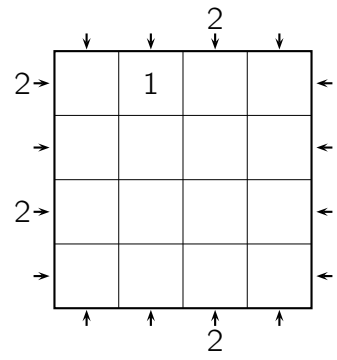

Gratte-ciel 16

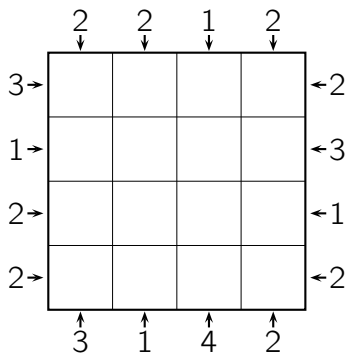

Gratte-ciel 16 *

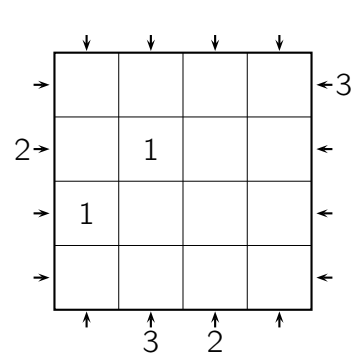

Participant

Classe 2024-2025

Participant

Classe 2024-2025

Slants 13

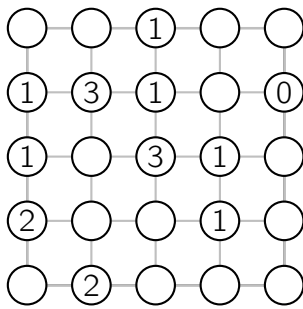

Slants 13 *

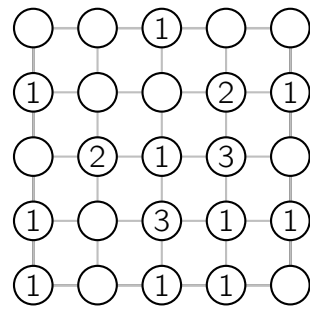

Slants 14

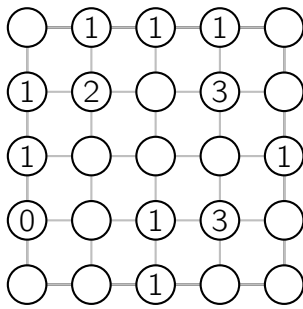

Slants 14 *

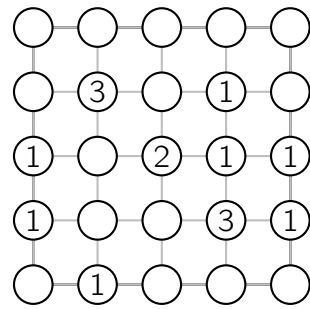

Slants 15

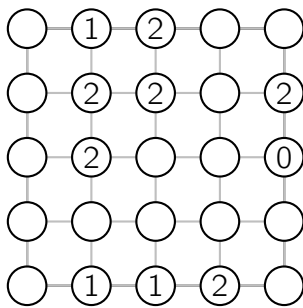

Slants 15 *

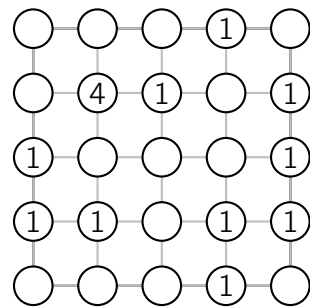

Slants 16

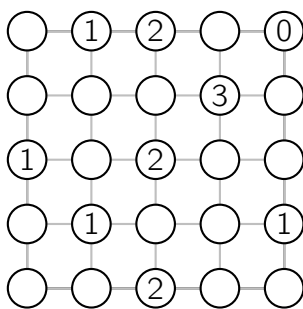

Slants 16 *

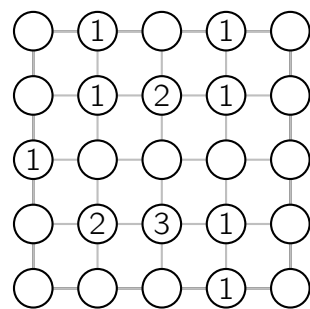

Participant

Classe 2024-2025

Participant

Classe 2024-2025

Squaro 13

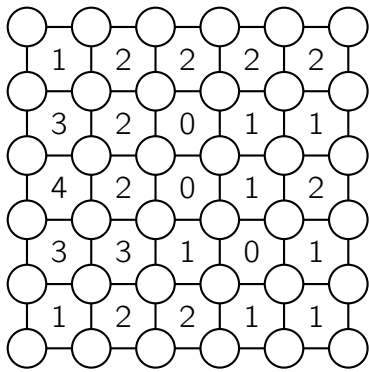

Squaro 13 *

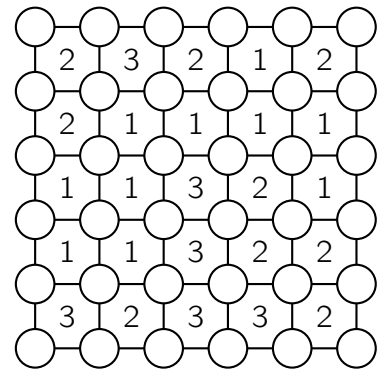

Squaro 14

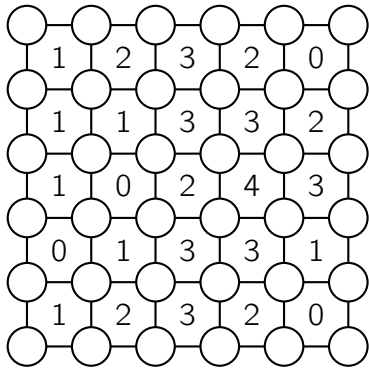

Squaro 14 *

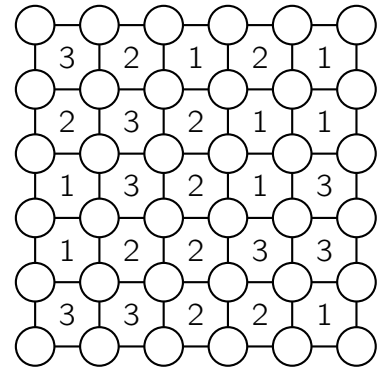

Squaro 15

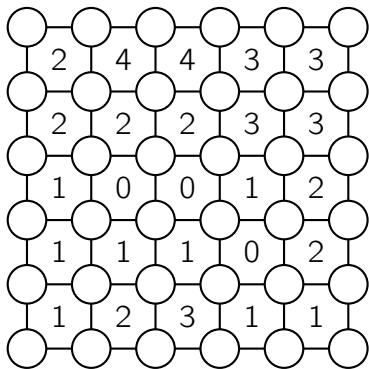

Squaro 15 *

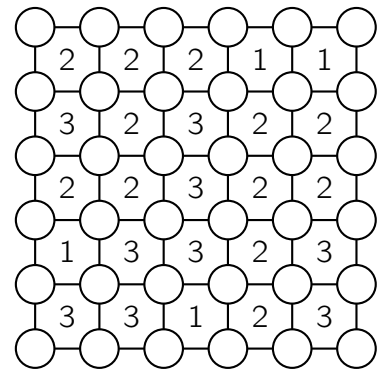

Squaro 16

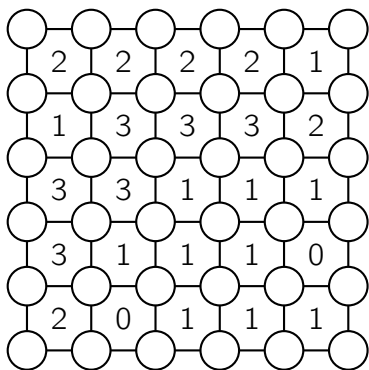

Squaro 16 *

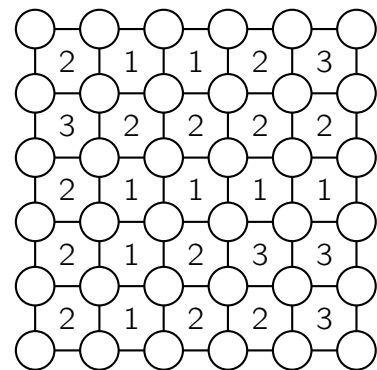

Participant

Classe 2024-2025

Participant

Classe 2024-2025

Tentes 13

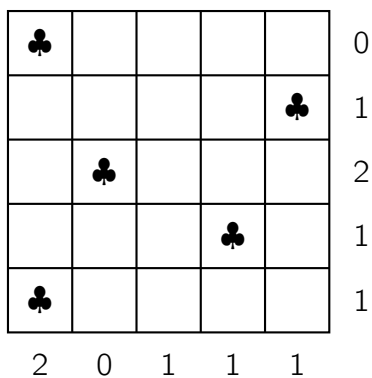

Tentes 13 *

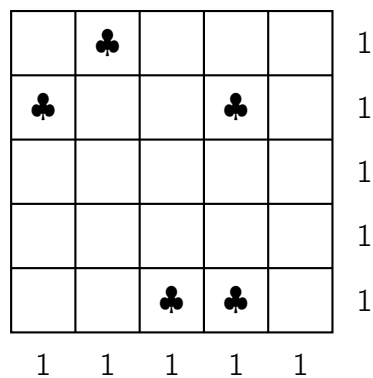

Tentes 14

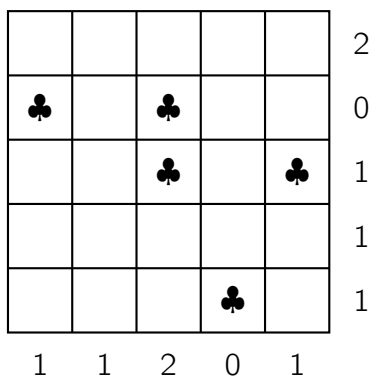

Tentes 14 *

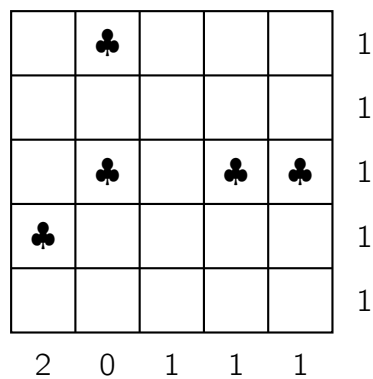

Tentes 15

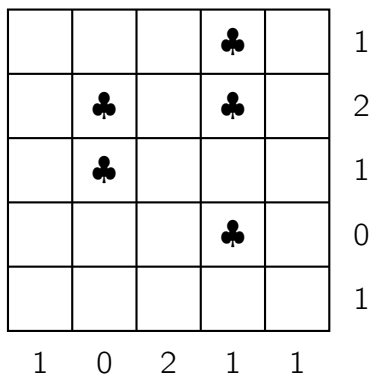

Tentes 15 *

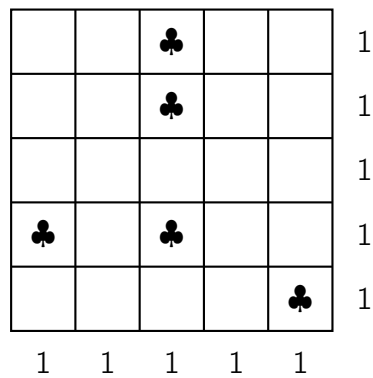

Tentes 16

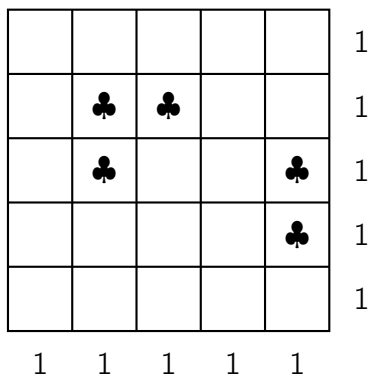

Tentes 16 *

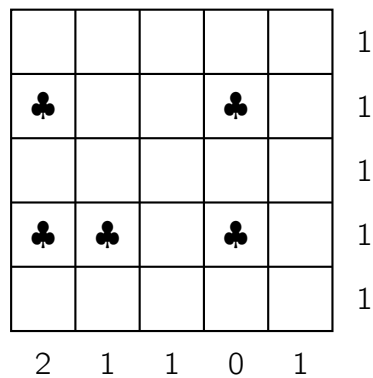

Participant

Classe 2024-2025

Participant

Classe 2024-2025

Tracks 13

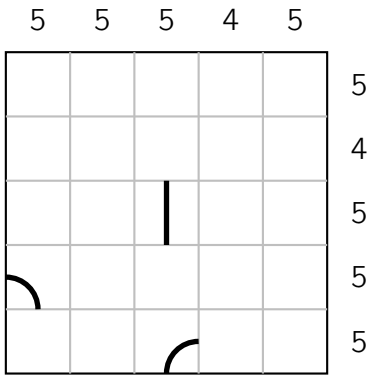

Tracks 13 *

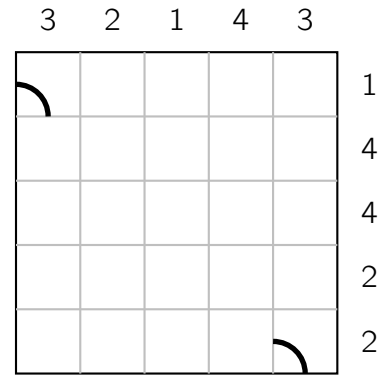

Tracks 14

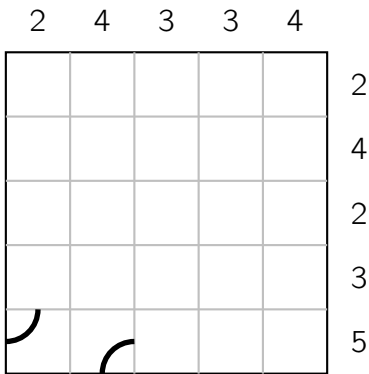

Tracks 14 *

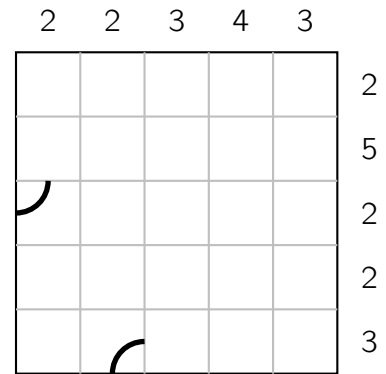

Tracks 15

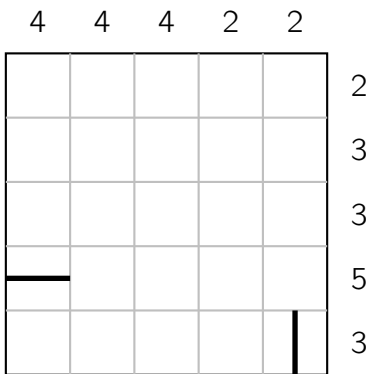

Tracks 15 *

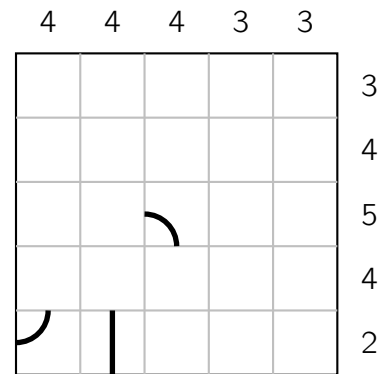

Tracks 16

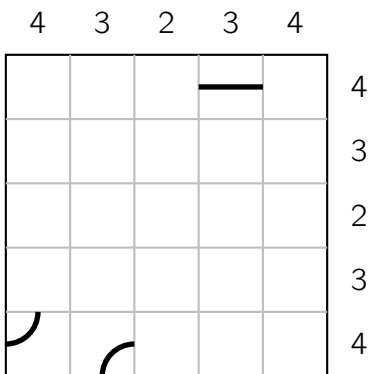

Tracks 16 *

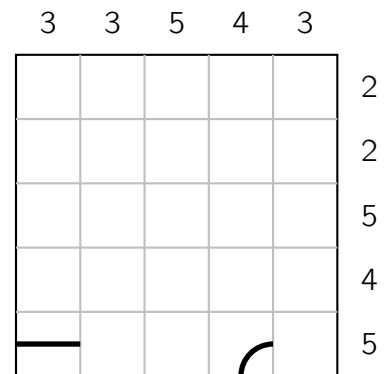

Participant

Classe 2024-2025

Participant

Classe 2024-2025

Corrigé 13

0	1	0	0	1	1
0	0	1	0	1	1
1	0	1	1	0	0
0	1	0	1	1	0
1	0	1	0	0	1
1	1	0	1	0	0

Corrigé 13 *

0	1	0	1	0	1
0	1	1	0	1	0
1	0	1	0	0	1
1	0	0	1	0	1
0	1	0	1	1	0
1	0	1	0	1	0

Corrigé 14

0	1	0	1	0	1
1	0	0	1	0	1
0	1	1	0	1	0
1	0	1	0	0	1
0	1	0	1	1	0
1	0	1	0	1	0

Corrigé 14 *

1	1	0	0	1	0
0	0	1	1	0	1
0	1	0	0	1	1
1	0	0	1	1	0
0	1	1	0	0	1
1	0	1	1	0	0

Corrigé 15

1	0	1	1	0	0
1	1	0	0	1	0
0	1	1	0	0	1
1	0	0	1	0	1
0	1	0	1	1	0
0	0	1	0	1	1

Corrigé 15 *

1	0	1	0	1	0
0	1	0	1	0	1
0	1	0	0	1	1
1	0	1	1	0	0
1	1	0	1	0	0
0	0	1	0	1	1

Corrigé 16

0	1	0	1	1	0
1	0	1	0	0	1
1	1	0	1	0	0
0	1	0	0	1	1
1	0	1	1	0	0
0	0	1	0	1	1

Corrigé 16 *

1	1	0	0	1	0
0	1	0	1	0	1
0	0	1	0	1	1
1	0	1	1	0	0
0	1	0	1	1	0
1	0	1	0	0	1

Corrigé 13

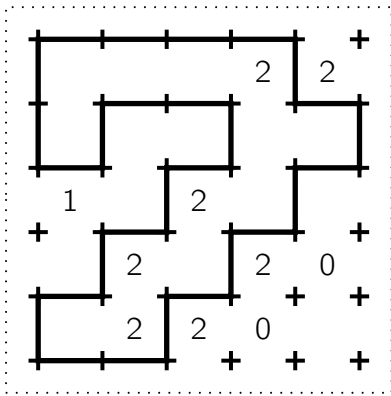

Corrigé 13 *

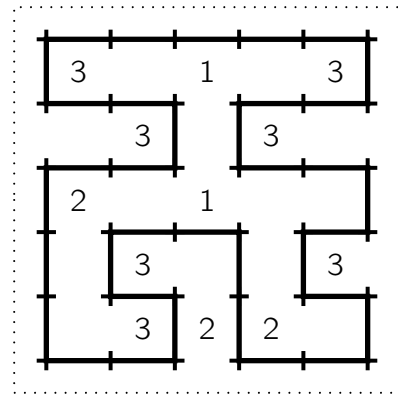

Corrigé 14

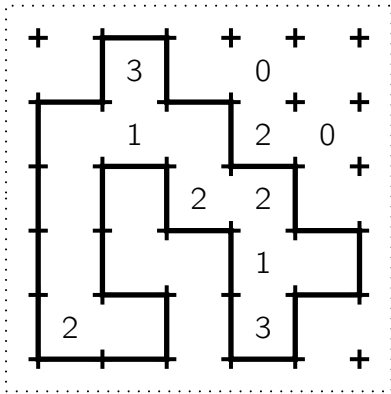

Corrigé 14 *

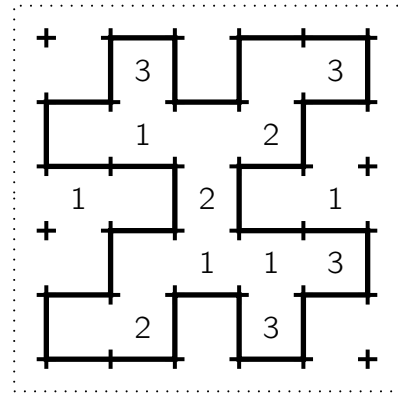

Corrigé 15

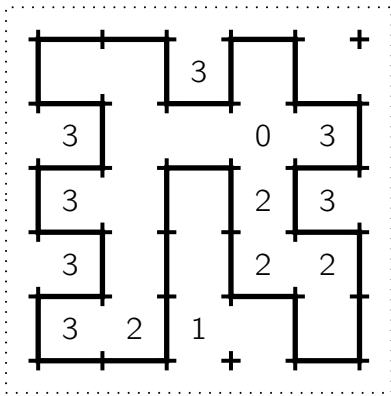

Corrigé 15 *

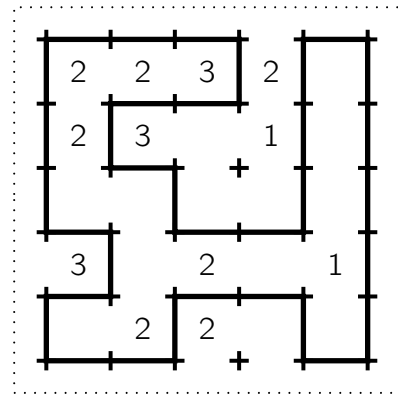

Corrigé 16

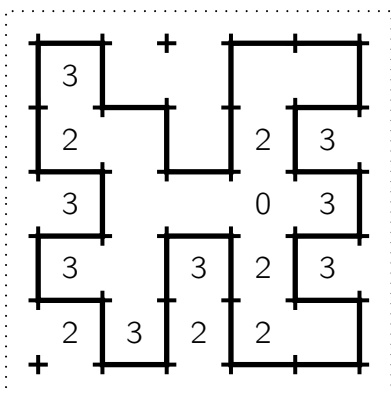

Corrigé 16 *

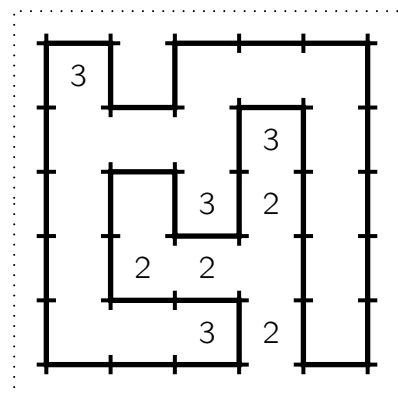

Corrigé 13

0	1	0	3	0
3	2	2	1	2
3	2	1	2	3
1	3	1	0	0

0·0	0·1	0·2	0·3	1·1
1·2	1·3	2·2	2·3	3·3

Corrigé 14

1	1	0	0	2
1	2	3	3	2
2	0	0	3	2
0	3	3	1	1

0·0	0·1	0·2	0·3	1·1
1·2	1·3	2·2	2·3	3·3

Corrigé 15

1	1	3	2	3
2	2	0	1	0
2	2	1	3	1
3	3	0	0	0

0·0	0·1	0·2	0·3	1·1
1·2	1·3	2·2	2·3	3·3

Corrigé 16

0	2	2	2	1
2	3	0	3	3
0	2	0	1	0
1	3	1	1	3

0·0	0·1	0·2	0·3	1·1
1·2	1·3	2·2	2·3	3·3

Corrigé 13 *

1	3	3	3	2
1	0	2	1	0
0	2	2	3	0
3	1	1	2	0

0·0	0·1	0·2	0·3	1·1
1·2	1·3	2·2	2·3	3·3

Corrigé 14 *

0	1	1	1	2
0	3	3	2	3
2	3	3	2	1
0	0	0	1	2

0·0	0·1	0·2	0·3	1·1
1·2	1·3	2·2	2·3	3·3

Corrigé 15 *

1	0	0	2	3
1	1	0	2	1
3	0	3	3	3
0	1	2	2	2

0·0	0·1	0·2	0·3	1·1
1·2	1·3	2·2	2·3	3·3

Corrigé 16 *

2	1	1	1	3
2	3	0	1	2
0	1	0	3	2
0	3	3	0	2

0·0	0·1	0·2	0·3	1·1
1·2	1·3	2·2	2·3	3·3

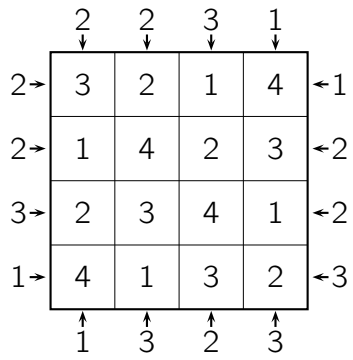

Corrigé 13

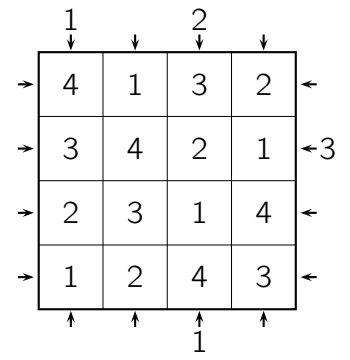

Corrigé 13

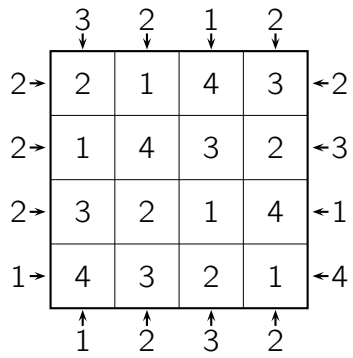

Corrigé 14

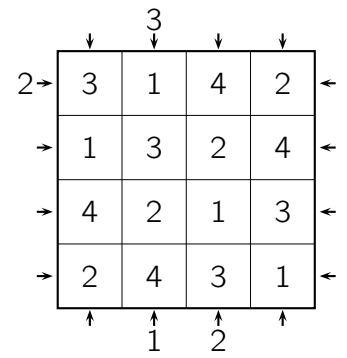

Corrigé 14

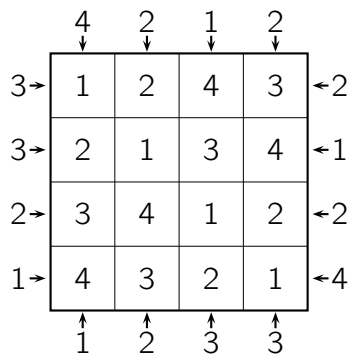

Corrigé 15

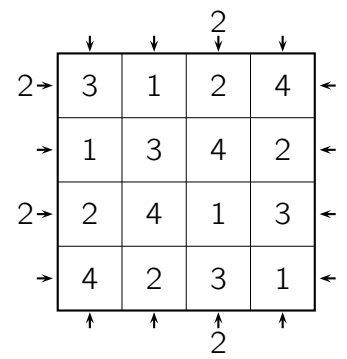

Corrigé 15

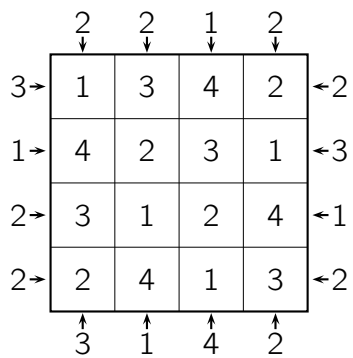

Corrigé 16

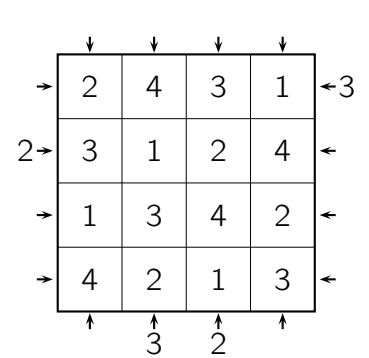

Corrigé 16

Corrigé 13

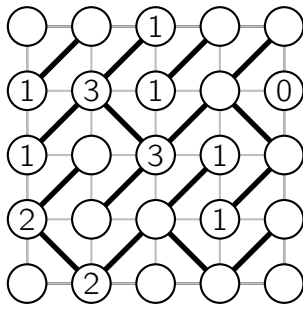

Corrigé 13 *

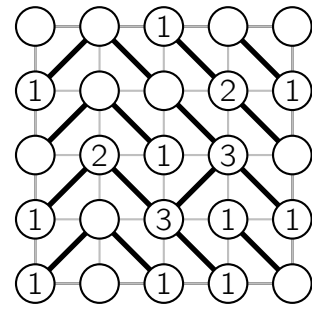

Corrigé 14

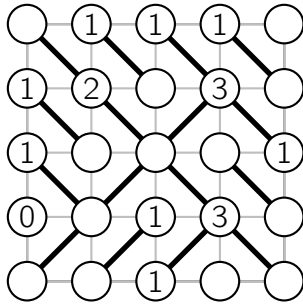

Corrigé 14 *

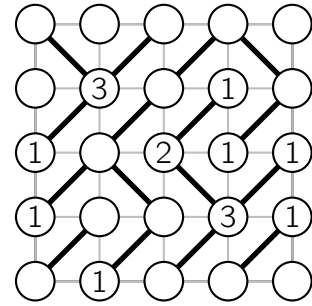

Corrigé 15

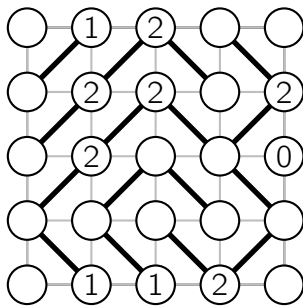

Corrigé 15 *

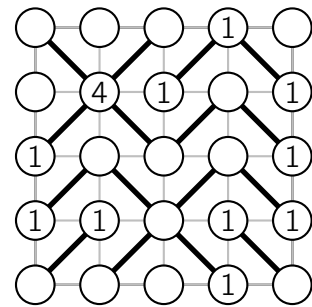

Corrigé 16

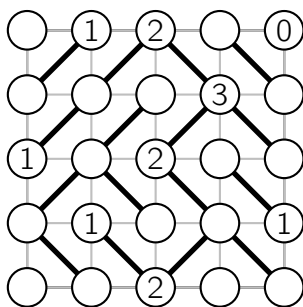

Corrigé 16 *

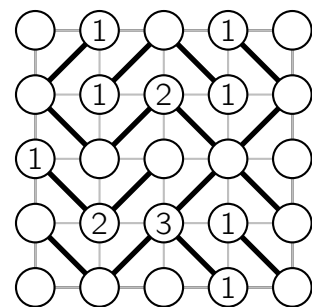

Corrigé 13

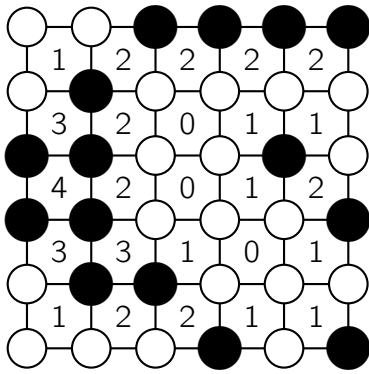

Corrigé 13 *

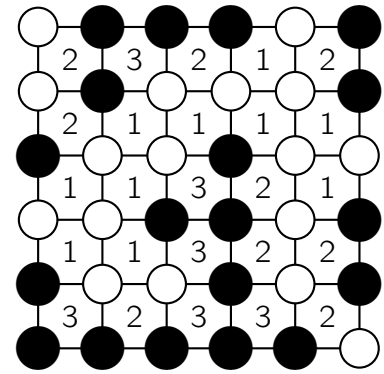

Corrigé 14

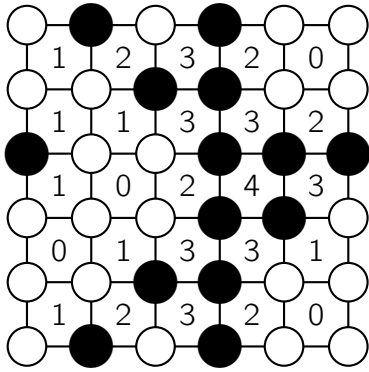

Corrigé 14 *

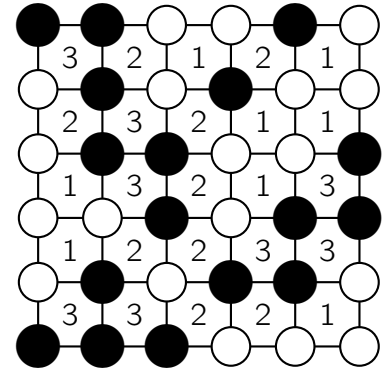

Corrigé 15

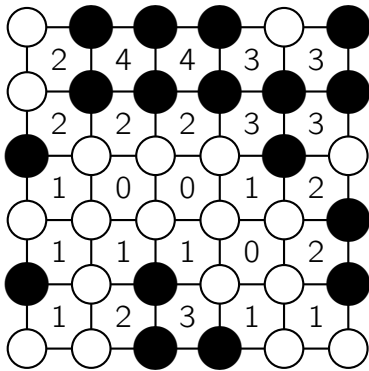

Corrigé 15 *

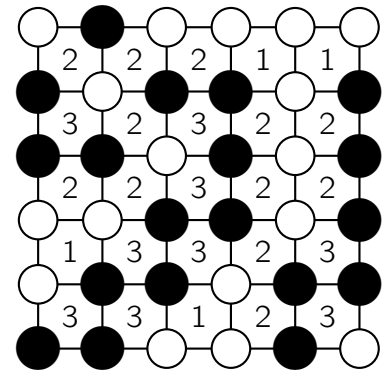

Corrigé 16

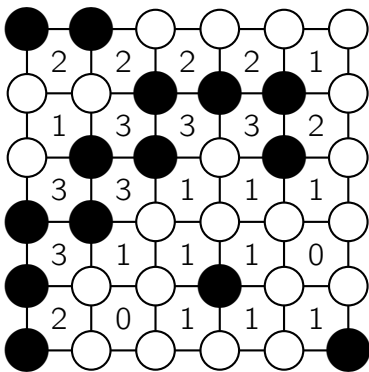

Corrigé 16 *

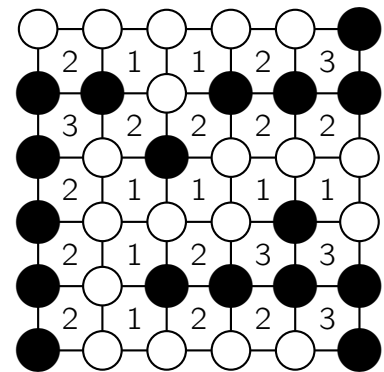

Corrigé 13

♣					0
△				♣	1
	♣	△		△	2
△			♣		1
♣			△		1
2	0	1	1	1	

Corrigé 13 *

	♣	△			1
♣			♣	△	1
△					1
			△		1
	△	♣	♣		1
1	1	1	1	1	

Corrigé 14

△		△			2
♣		♣			0
	△	♣		♣	1
				△	1
		△	♣		1
1	1	2	0	1	

Corrigé 14 *

	♣	△			1
				△	1
△	♣		♣	♣	1
♣			△		1
△					1
2	0	1	1	1	

Corrigé 15

		△	♣		1
△	♣		♣	△	2
	♣	△			1
			♣		0
			△		1
1	0	2	1	1	

Corrigé 15 *

	△	♣			1
		♣	△		1
△					1
♣		♣		△	1
		△		♣	1
1	1	1	1	1	

Corrigé 16

		△			1
△	♣	♣			1
	♣		△	♣	1
	△			♣	1
				△	1
1	1	1	1	1	

Corrigé 16 *

△					1
♣		△	♣		1
△					1
♣	♣		♣	△	1
	△				1
2	1	1	0	1	

