

Binaro 9

			0		
1	1		0		
	1				
1				1	
		0		0	0

Binaro 9 *

			0		
	0	0		1	
					0
	1				
			0	1	

Binaro 10

0		1			
	1		1		1
		1			
					0
1		1		1	

Binaro 10 *

		0			1
0					
		0	0		0
		1		1	1

Binaro 11

1					
	0	0			
		0		0	0
				0	
		0			

Binaro 11 *

				1	
0		1		1	
					0
0		0			
0					0

Binaro 12

		0	1		1
		0	1		
0		0			
					1
				0	0

Binaro 12 *

	1	1			0
				1	1
	1				
					0

Participant

Classe 2024-2025

Participant

Classe 2024-2025

Clôtures 9

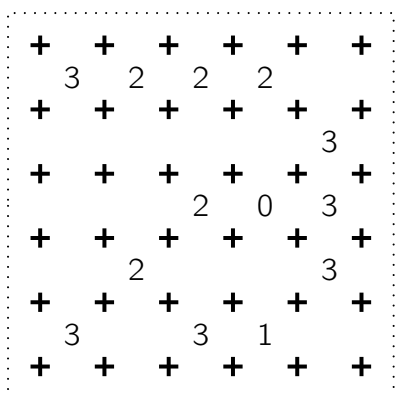

Clôtures 9 *

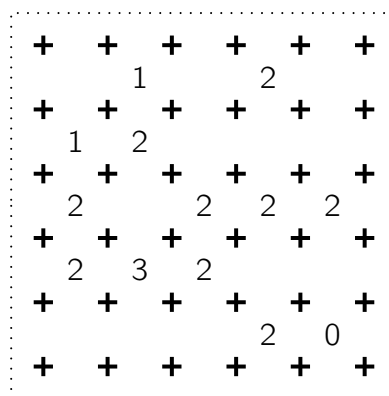

Clôtures 10

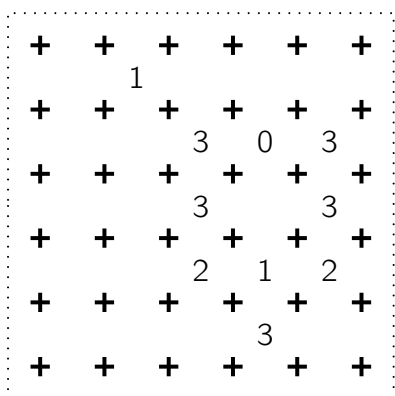

Clôtures 10 *

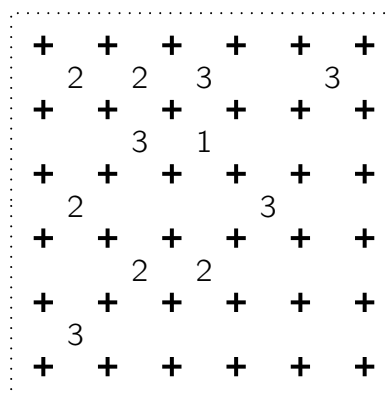

Clôtures 11

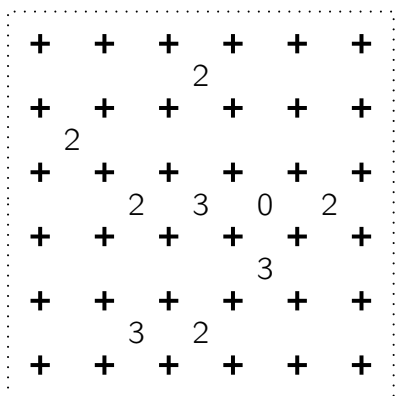

Clôtures 11 *

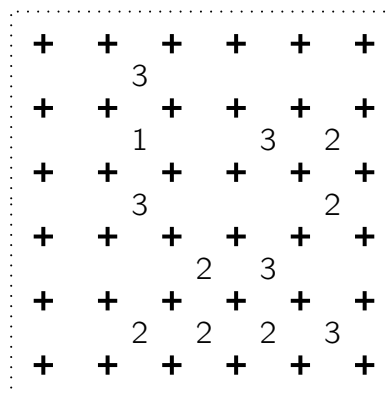

Clôtures 12

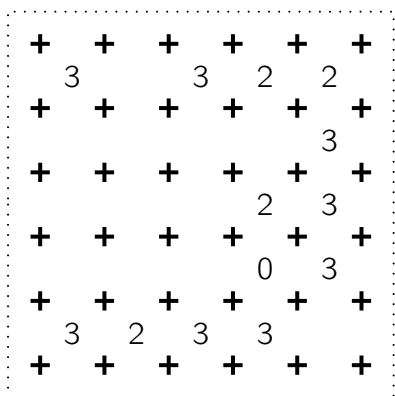

Clôtures 12 *

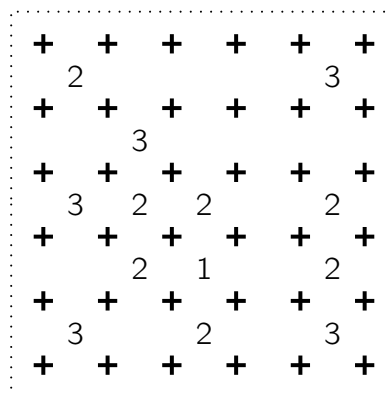

Participant

Classe 2024-2025

Participant

Classe 2024-2025

Dominos 9

3	0	1	3	1
2	2	0	1	0
3	2	1	1	2
3	3	0	0	2

0·0	0·1	0·2	0·3	1·1
1·2	1·3	2·2	2·3	3·3

Dominos 9 *

3	3	3	1	1
1	1	3	2	0
2	2	2	2	0
3	0	0	1	0

0·0	0·1	0·2	0·3	1·1
1·2	1·3	2·2	2·3	3·3

Dominos 10

0	1	0	0	3
2	2	1	3	0
1	2	1	2	0
3	2	3	3	1

0·0	0·1	0·2	0·3	1·1
1·2	1·3	2·2	2·3	3·3

Dominos 10 *

0	2	1	3	3
1	0	0	0	1
1	1	3	2	2
3	3	0	2	2

0·0	0·1	0·2	0·3	1·1
1·2	1·3	2·2	2·3	3·3

Dominos 11

2	2	3	2	1
1	3	0	0	3
0	0	1	2	0
2	1	1	3	3

0·0	0·1	0·2	0·3	1·1
1·2	1·3	2·2	2·3	3·3

Dominos 11 *

1	1	1	2	1
3	0	0	2	1
3	0	0	3	2
3	0	2	3	2

0·0	0·1	0·2	0·3	1·1
1·2	1·3	2·2	2·3	3·3

Dominos 12

0	1	0	1	3
2	2	0	2	3
3	1	1	3	1
0	3	2	0	2

0·0	0·1	0·2	0·3	1·1
1·2	1·3	2·2	2·3	3·3

Dominos 12 *

3	1	1	0	2
3	2	2	3	2
2	3	0	1	1
0	0	3	1	0

0·0	0·1	0·2	0·3	1·1
1·2	1·3	2·2	2·3	3·3

Participant

Classe 2024-2025

Participant

Classe 2024-2025

Gratte-ciel 9

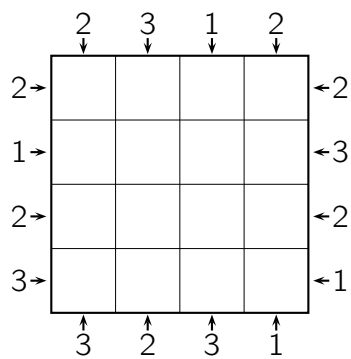

Gratte-ciel 9 *

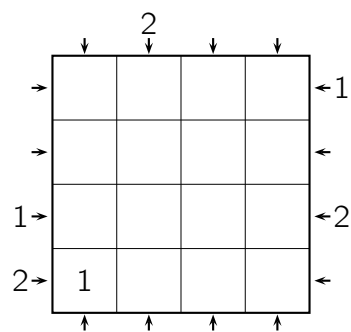

Gratte-ciel 10

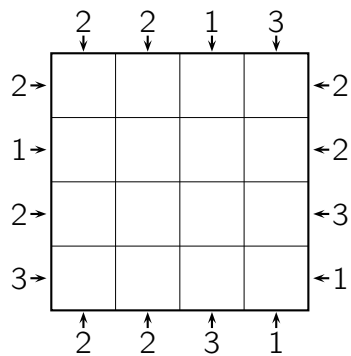

Gratte-ciel 10 *

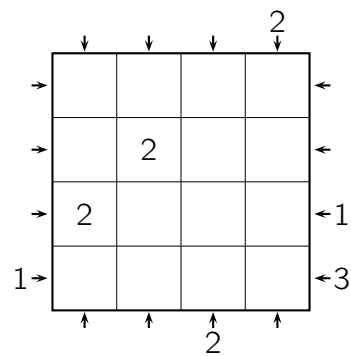

Gratte-ciel 11

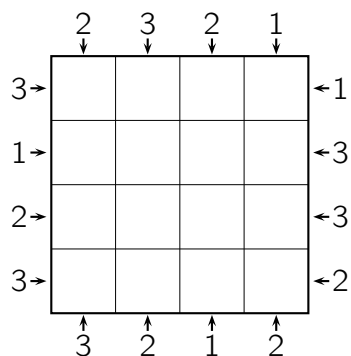

Gratte-ciel 11 *

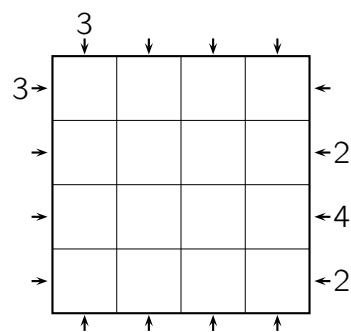

Gratte-ciel 12

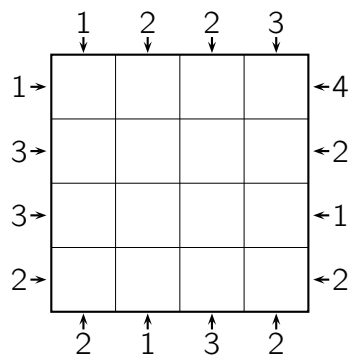

Gratte-ciel 12 *

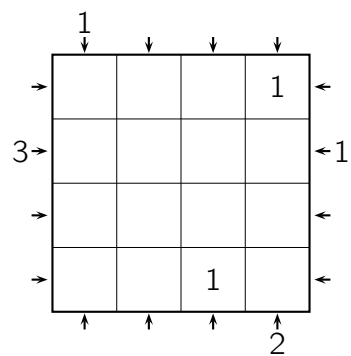

Participant

Classe 2024-2025

Participant

Classe 2024-2025

Slants 9

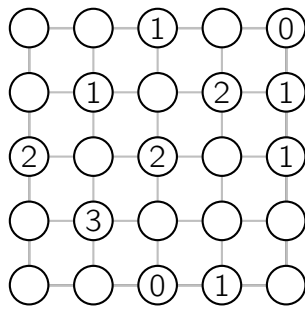

Slants 9 *

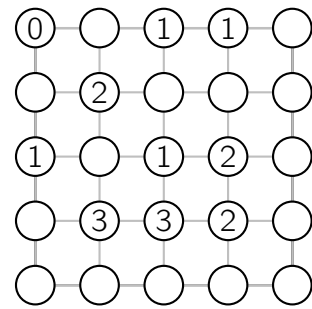

Slants 10

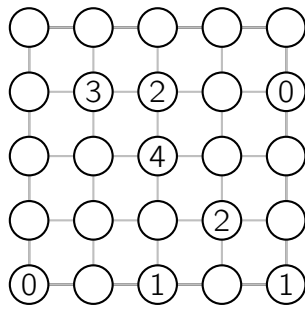

Slants 10 *

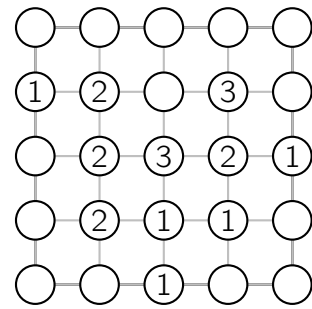

Slants 11

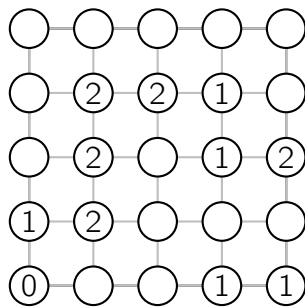

Slants 11 *

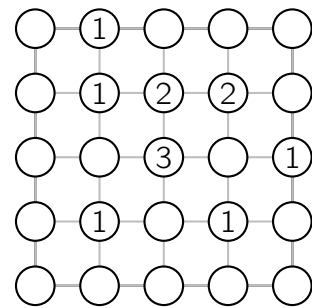

Slants 12

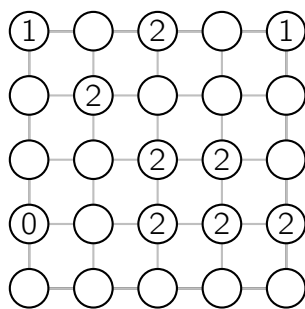

Slants 12 *

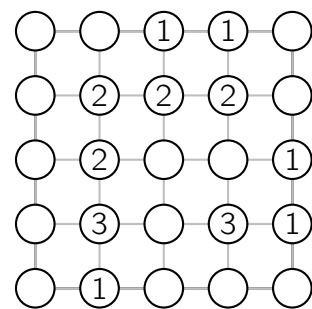

Participant

Classe 2024-2025

Participant

Classe 2024-2025

Squaro 9

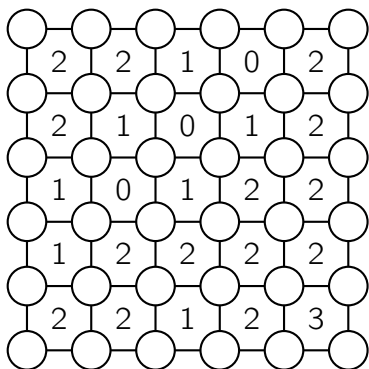

Squaro 9 *

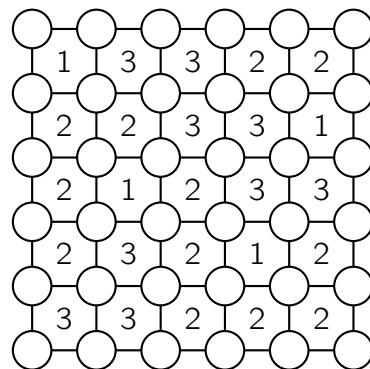

Squaro 10

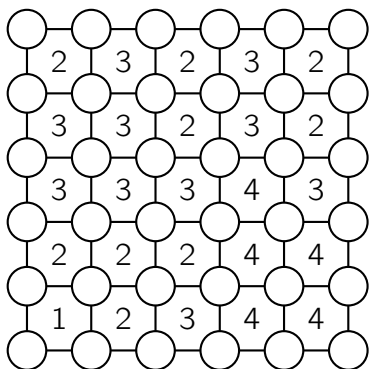

Squaro 10 *

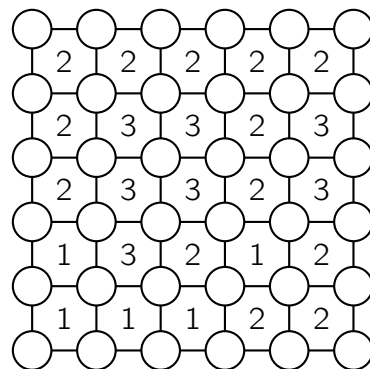

Squaro 11

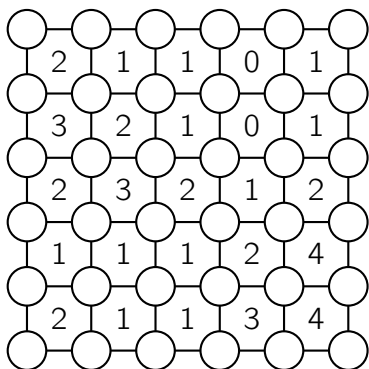

Squaro 11 *

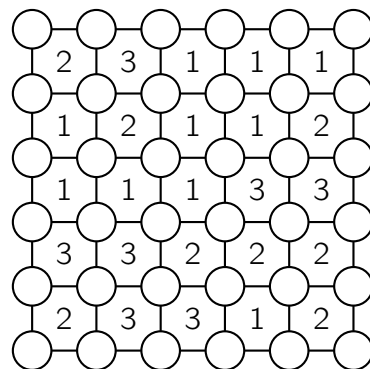

Squaro 12

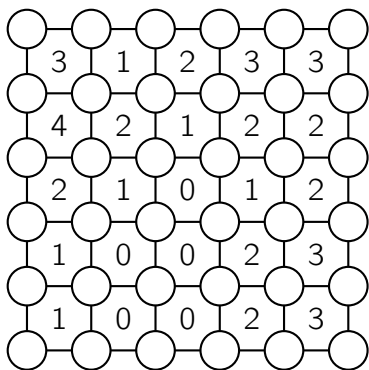

Squaro 12 *

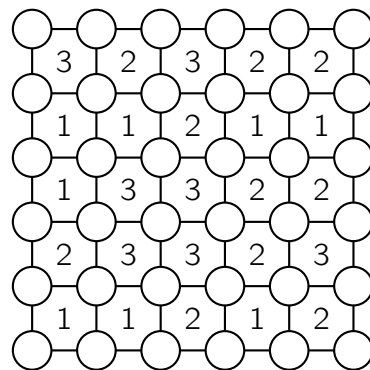

Participant

Classe 2024-2025

Participant

Classe 2024-2025

Tentes 9

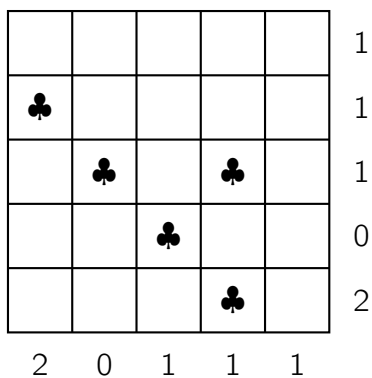

Tentes 9 *

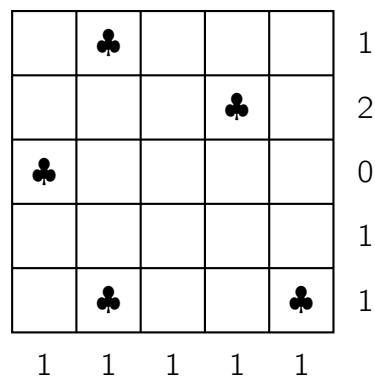

Tentes 10

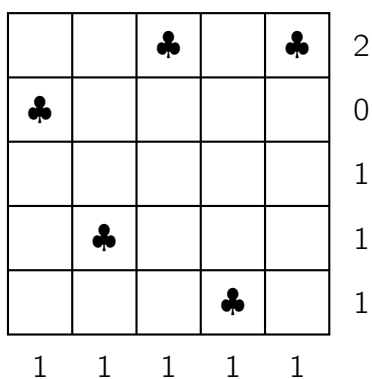

Tentes 10 *

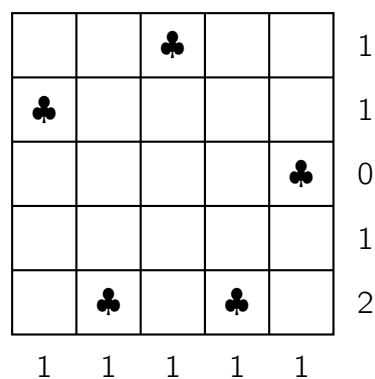

Tentes 11

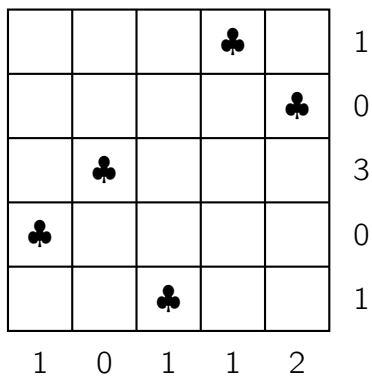

Tentes 11 *

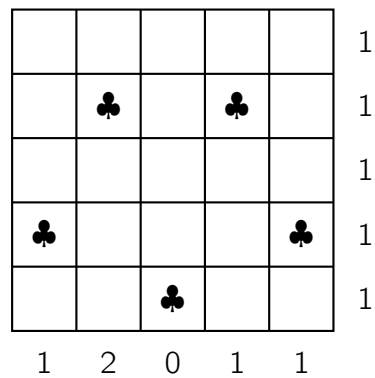

Tentes 12

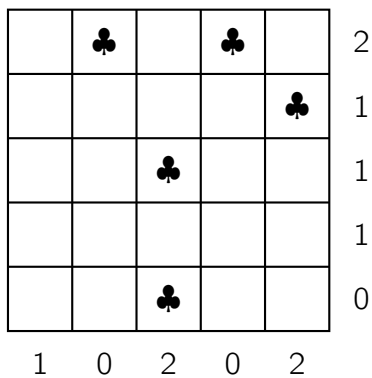

Tentes 12 *

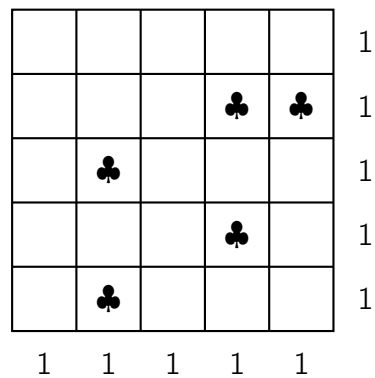

Participant

Classe 2024-2025

Participant

Classe 2024-2025

Tracks 9

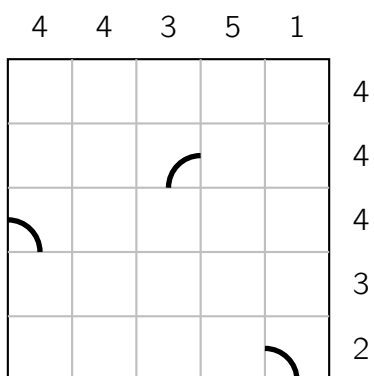

Tracks 9 *

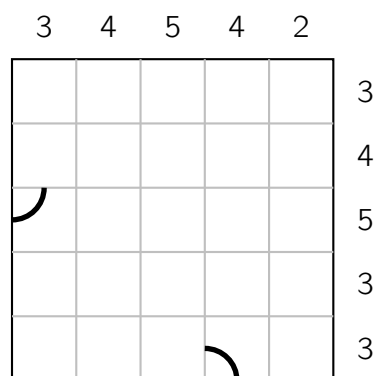

Tracks 10

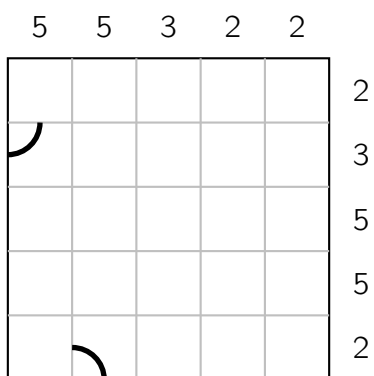

Tracks 10 *

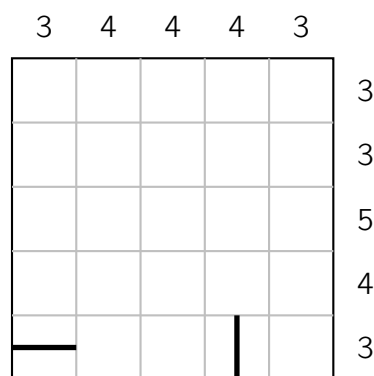

Tracks 11

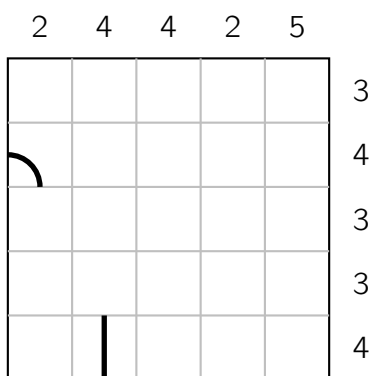

Tracks 11 *

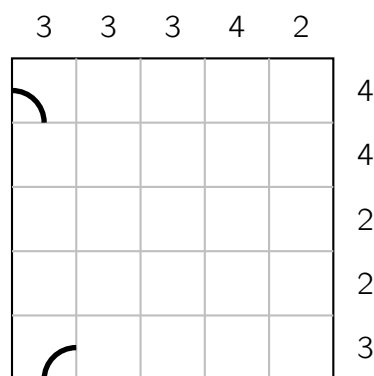

Tracks 12

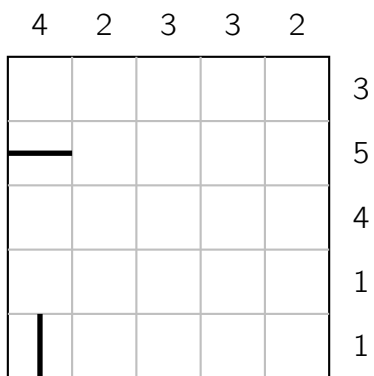

Tracks 12 *

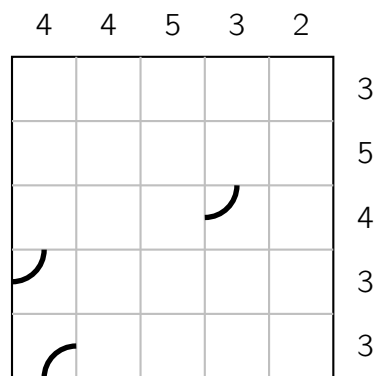

Participant

Classe 2024-2025

Participant

Classe 2024-2025

Corrigé 9

0	0	1	0	1	1
1	1	0	0	1	0
0	1	0	1	0	1
0	0	1	1	0	1
1	0	1	0	1	0
1	1	0	1	0	0

Corrigé 9 *

0	1	1	0	0	1
1	0	0	1	0	1
1	0	0	1	1	0
0	1	1	0	1	0
0	1	0	1	0	1
1	0	1	0	1	0

Corrigé 10

1	0	0	1	0	1
0	1	1	0	1	0
0	1	0	1	0	1
1	0	1	0	0	1
0	1	0	1	1	0
1	0	1	0	1	0

Corrigé 10 *

1	0	0	1	0	1
0	1	1	0	1	0
0	0	1	1	0	1
1	1	0	0	1	0
1	1	0	1	0	0
0	0	1	0	1	1

Corrigé 11

1	0	1	0	1	0
1	0	0	1	0	1
0	1	1	0	1	0
1	1	0	1	0	0
0	0	1	1	0	1
0	1	0	0	1	1

Corrigé 11 *

1	0	0	1	0	1
1	1	0	0	1	0
0	0	1	0	1	1
1	0	1	1	0	0
0	1	0	1	0	1
0	1	1	0	1	0

Corrigé 12

0	1	0	1	0	1
1	0	1	0	1	0
1	1	0	1	0	0
0	1	0	0	1	1
0	0	1	0	1	1
1	0	1	1	0	0

Corrigé 12 *

0	1	1	0	1	0
0	1	0	0	1	1
1	0	1	1	0	0
0	1	0	1	0	1
1	0	1	0	1	0
1	0	0	1	0	1

Corrigé 9

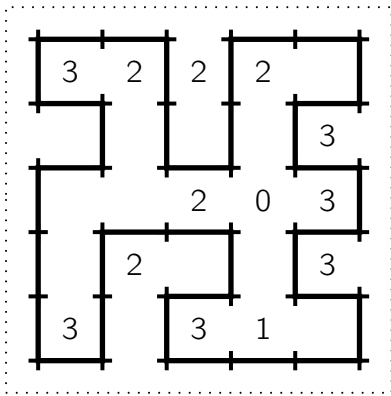

Corrigé 9 *

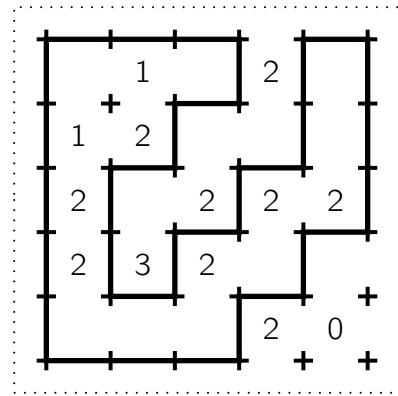

Corrigé 10

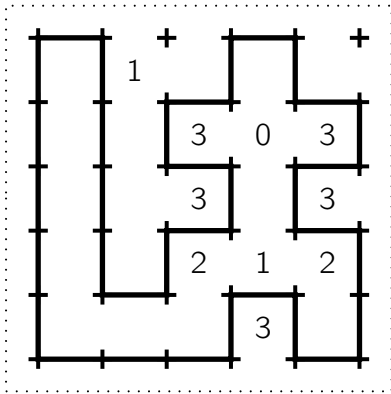

Corrigé 10 *

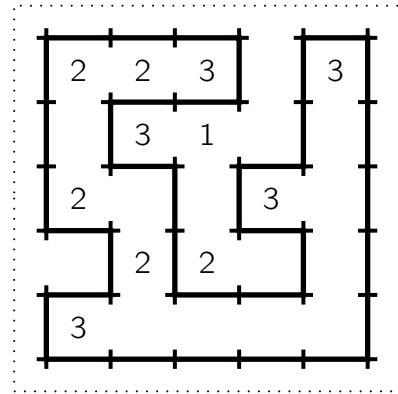

Corrigé 11

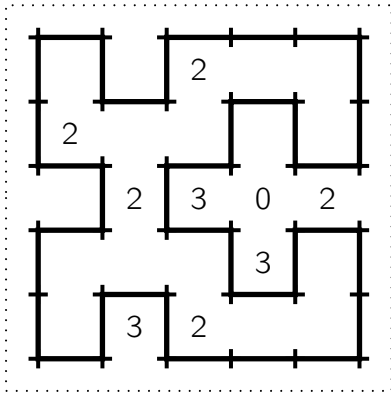

Corrigé 11 *

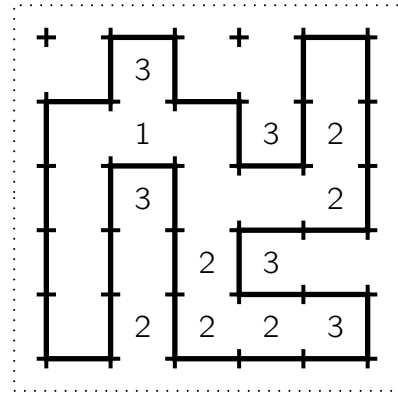

Corrigé 12

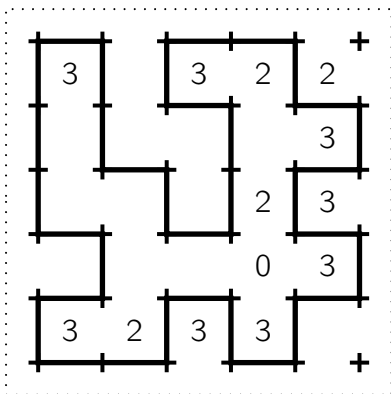

Corrigé 12 *

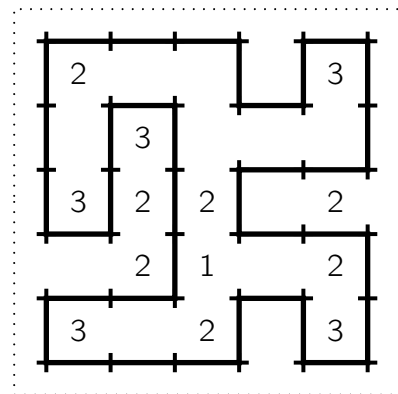

Corrigé 9

3	0	1	3	1
2	2 0		1	0
3	2 1		1	2
3 3		0 0		2

0·0	0·1	0·2	0·3	1·1
1·2	1·3	2·2	2·3	3·3

Corrigé 10

0	1	0 0		3
2	2	1	3	0
1	2	1	2	0
3	2	3 3		1

0·0	0·1	0·2	0·3	1·1
1·2	1·3	2·2	2·3	3·3

Corrigé 11

2 2		3	2	1
1	3	0 0		3
0	0	1	2 0	
2 1		1	3 3	

0·0	0·1	0·2	0·3	1·1
1·2	1·3	2·2	2·3	3·3

Corrigé 12

0	1	0	1	3
2 2		0	2	3
3	1 1		3	1
0	3 2		0	2

0·0	0·1	0·2	0·3	1·1
1·2	1·3	2·2	2·3	3·3

Corrigé 9 *

3 3		3 1		1
1	1	3 2		0
2 2		2	2	0
3 0		0	1	0

0·0	0·1	0·2	0·3	1·1
1·2	1·3	2·2	2·3	3·3

Corrigé 10 *

0	2 1		3	3
1	0 0		0	1
1	1	3 2		2
3 3		0	2	2

0·0	0·1	0·2	0·3	1·1
1·2	1·3	2·2	2·3	3·3

Corrigé 11 *

1	1	1 2		1
3	0	0 2		1
3	0	0 3		2
3	0	2 3		2

0·0	0·1	0·2	0·3	1·1
1·2	1·3	2·2	2·3	3·3

Corrigé 12 *

3	1 1		0 2	
3	2 2		3	2
2 3		0	1	1
0 0		3	1 0	

0·0	0·1	0·2	0·3	1·1
1·2	1·3	2·2	2·3	3·3

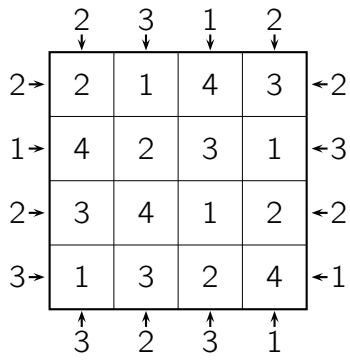

Corrigé 9

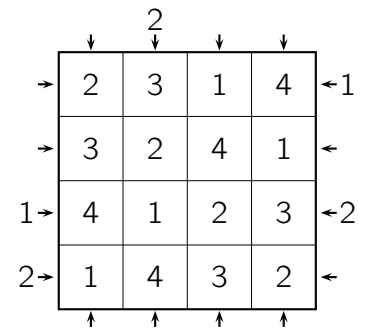

Corrigé 9

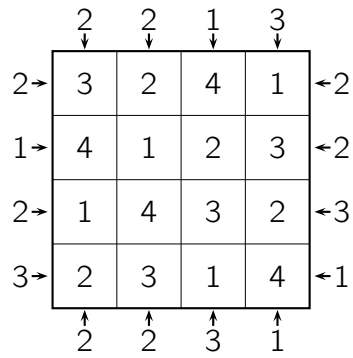

Corrigé 10

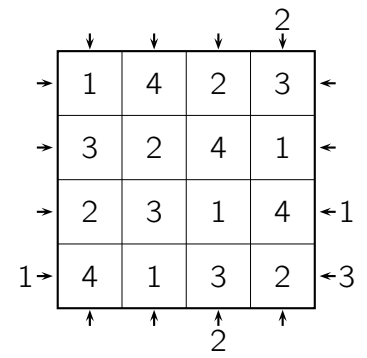

Corrigé 10

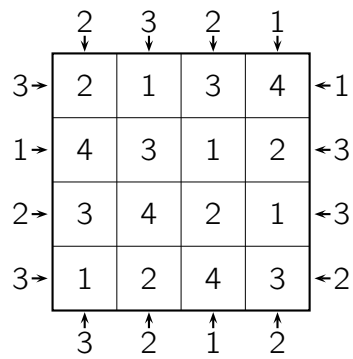

Corrigé 11

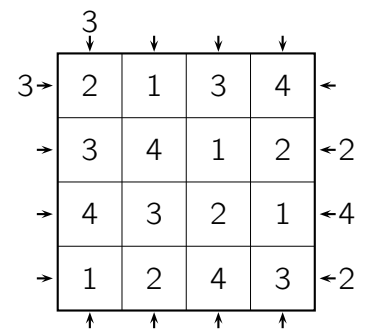

Corrigé 11

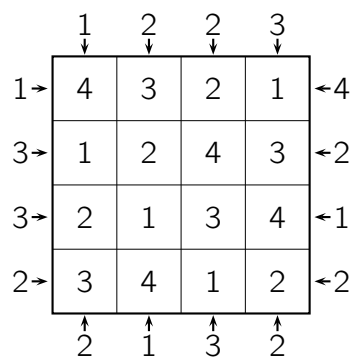

Corrigé 12

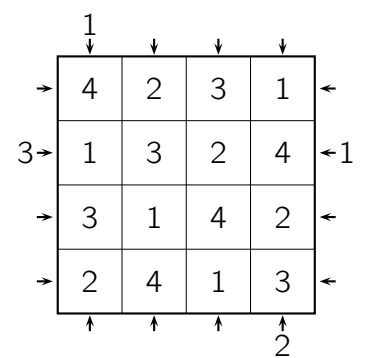

Corrigé 12

Corrigé 9

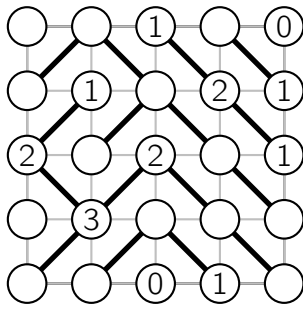

Corrigé 9 *

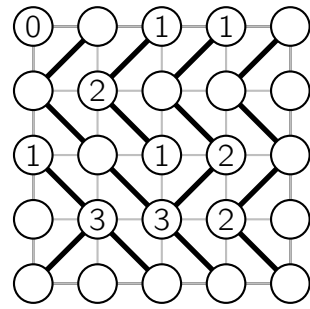

Corrigé 10

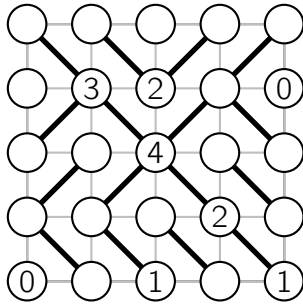

Corrigé 10 *

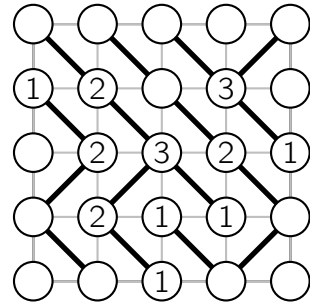

Corrigé 11

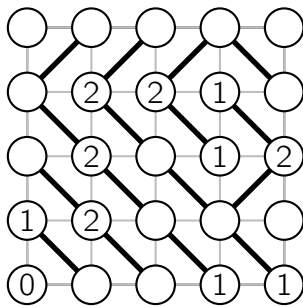

Corrigé 11 *

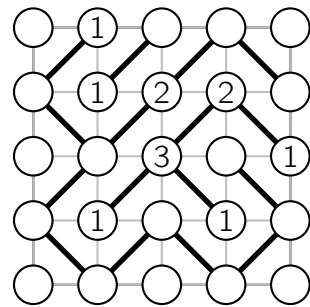

Corrigé 12

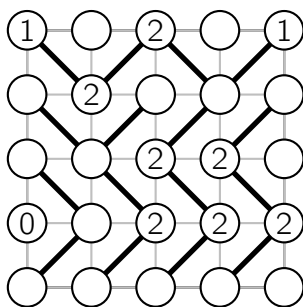

Corrigé 12 *

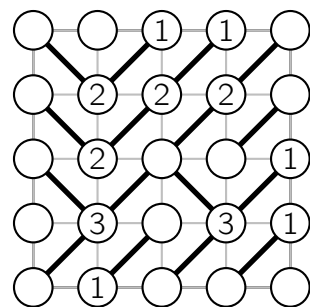

Corrigé 9

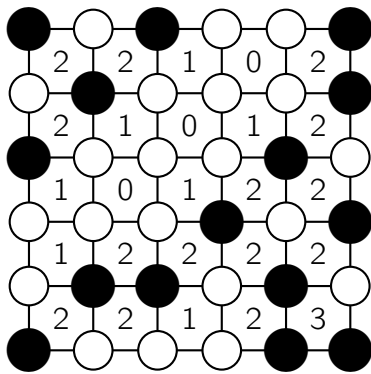

Corrigé 9 *

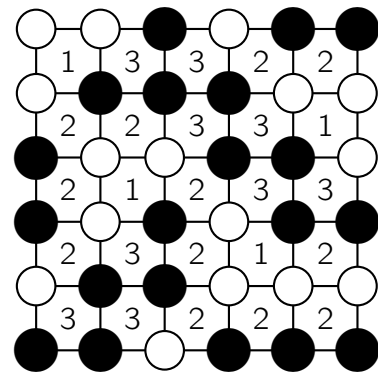

Corrigé 10

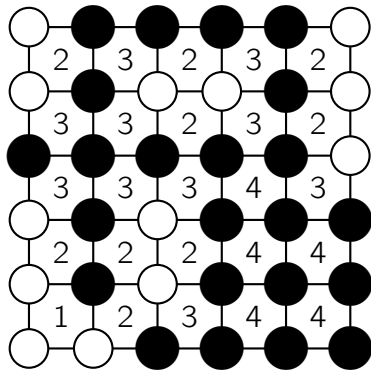

Corrigé 10 *

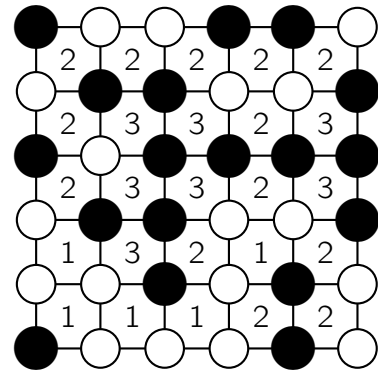

Corrigé 11

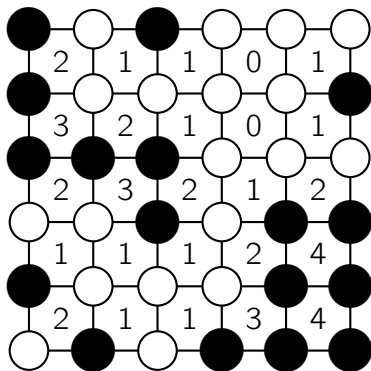

Corrigé 11 *

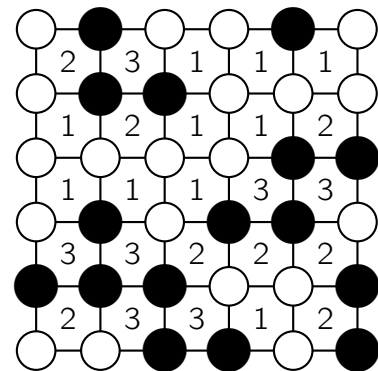

Corrigé 12

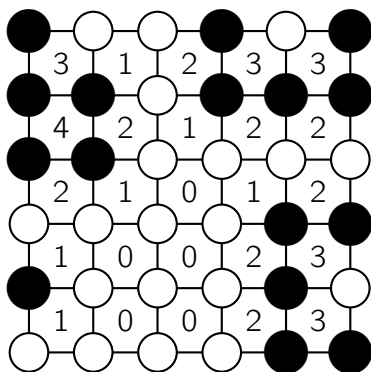

Corrigé 12 *

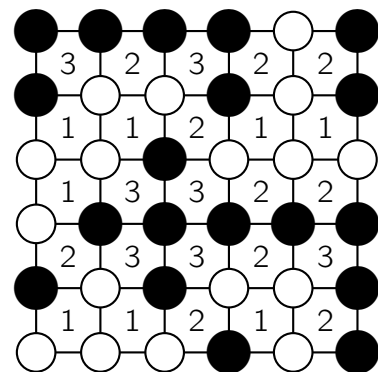

Corrigé 9

△					1
♣			△		1
△	♣		♣		1
		♣			0
		△	♣	△	2
2	0	1	1	1	

Corrigé 9 *

	♣	△			1
△			♣	△	2
♣					0
	△				1
	♣		△	♣	1
1	1	1	1	1	

Corrigé 10

	△	♣	△	♣	2
♣					0
△					1
	♣	△			1
			♣	△	1
1	1	1	1	1	

Corrigé 10 *

		♣	△		1
♣	△				1
				♣	0
				△	1
△	♣	△	♣		2
1	1	1	1	1	

Corrigé 11

			♣	△	1
				♣	0
△	♣	△		△	3
♣					0
		♣	△		1
1	0	1	1	2	

Corrigé 11 *

	△				1
	♣		♣	△	1
△					1
♣			△	♣	1
	△	♣			1
1	2	0	1	1	

Corrigé 12

△	♣		♣	△	2
		△		♣	1
		♣		△	1
		△			1
		♣			0
1	0	2	0	2	

Corrigé 12 *

			△		1
	△		♣	♣	1
	♣			△	1
		△	♣		1
△	♣				1
1	1	1	1	1	

