

### Binaro 1

	1				
1	1				
		0			
	0			0	
		1			0

### Binaro 1 \*

			1		
1		0		0	
		0			1
			1		
		0			

### Binaro 2

				1	
		1			0
	0		0		0
	1				
				1	1

### Binaro 2 \*

0			1		
				1	
		0			
1				1	
		0			
0					

### Binaro 3

					0
		0			
1	1		1		
				0	
		1			
0					0

### Binaro 3 \*

1					
		0			
					0
1		0		1	
	0				
1					

### Binaro 4

				1	1
	0	0			
				1	
1		1			
	0		0		

### Binaro 4 \*

					0
	1		0		
			0		0
0					0
	1		1		

Participant .....

Classe ..... 2024-2025

Participant .....

Classe ..... 2024-2025

### Clôtures 1

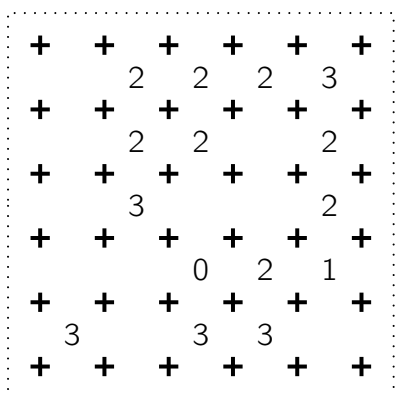

### Clôtures 1 \*

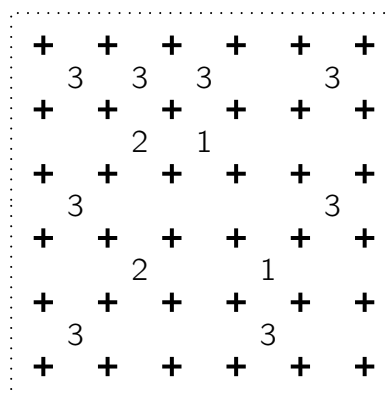

### Clôtures 2

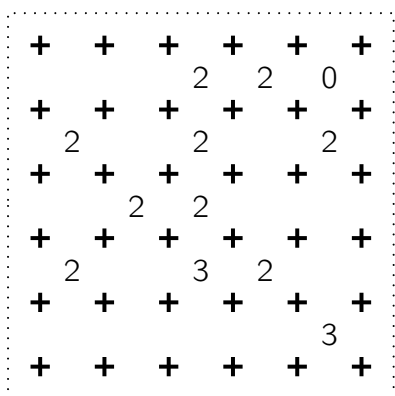

### Clôtures 2 \*

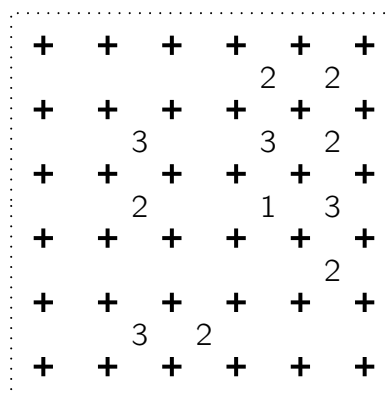

### Clôtures 3

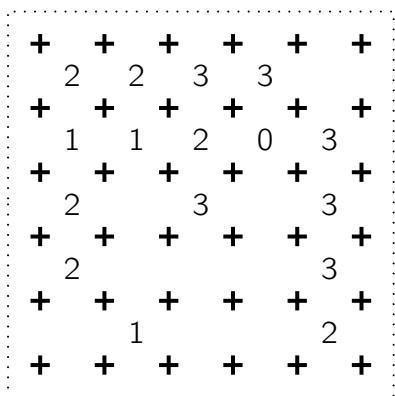

### Clôtures 3 \*

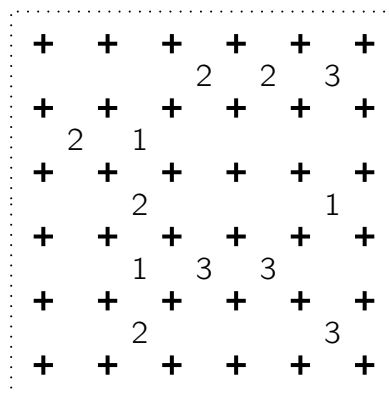

### Clôtures 4

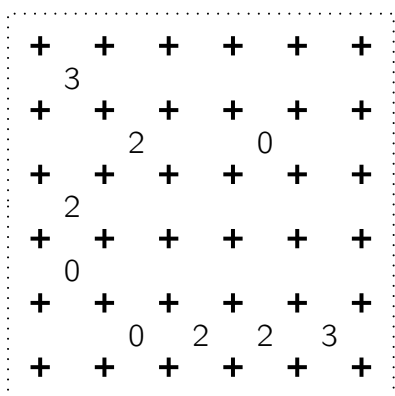

### Clôtures 4 \*

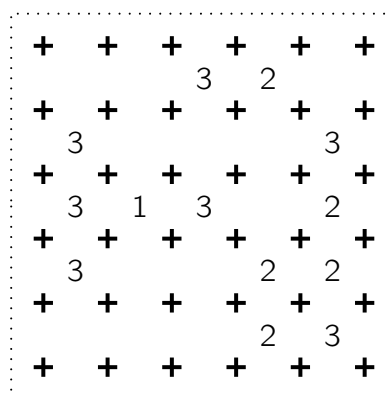

Participant .....

Classe ..... 2024-2025

Participant .....

Classe ..... 2024-2025

**Dominos 1**

1	1	0	3	0
3	0	2	1	0
2	2	3	3	1
2	0	1	3	2

0·0	0·1	0·2	0·3	1·1
1·2	1·3	2·2	2·3	3·3

**Dominos 1 \***

1	1	0	3	0
2	3	1	2	0
2	1	3	3	1
2	0	0	2	3

0·0	0·1	0·2	0·3	1·1
1·2	1·3	2·2	2·3	3·3

**Dominos 2**

0	3	0	1	1
0	1	2	0	3
1	3	3	2	2
2	3	1	0	2

0·0	0·1	0·2	0·3	1·1
1·2	1·3	2·2	2·3	3·3

**Dominos 2 \***

0	0	2	1	1
1	1	1	0	0
3	3	0	2	3
2	3	2	2	3

0·0	0·1	0·2	0·3	1·1
1·2	1·3	2·2	2·3	3·3

**Dominos 3**

0	1	3	1	0
2	1	3	2	2
2	3	1	0	1
0	3	3	0	2

0·0	0·1	0·2	0·3	1·1
1·2	1·3	2·2	2·3	3·3

**Dominos 3 \***

2	1	3	1	0
3	0	0	2	2
1	1	3	1	3
0	0	3	2	2

0·0	0·1	0·2	0·3	1·1
1·2	1·3	2·2	2·3	3·3

**Dominos 4**

0	1	2	3	2
0	1	2	1	0
1	0	3	1	2
3	3	2	3	0

0·0	0·1	0·2	0·3	1·1
1·2	1·3	2·2	2·3	3·3

**Dominos 4 \***

1	1	2	3	3
2	1	1	0	2
2	0	0	3	2
3	1	3	0	0

0·0	0·1	0·2	0·3	1·1
1·2	1·3	2·2	2·3	3·3

Participant .....

Classe ..... 2024-2025

Participant .....

Classe ..... 2024-2025

**Gratte-ciel 1**

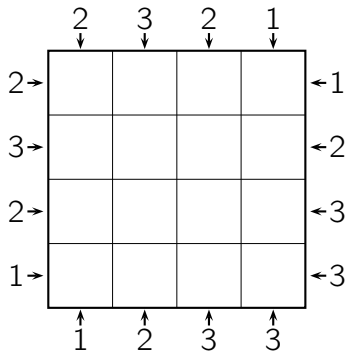

**Gratte-ciel 1 \***

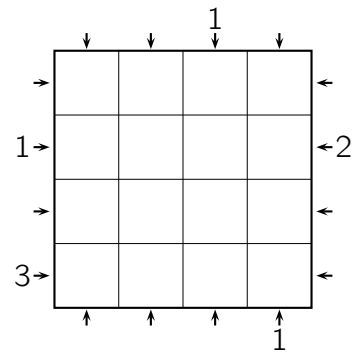

**Gratte-ciel 2**

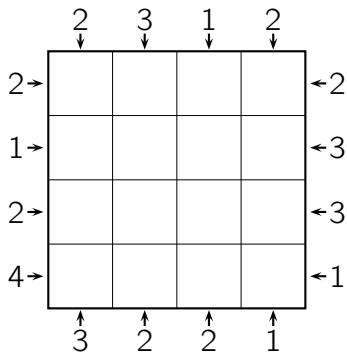

**Gratte-ciel 2 \***

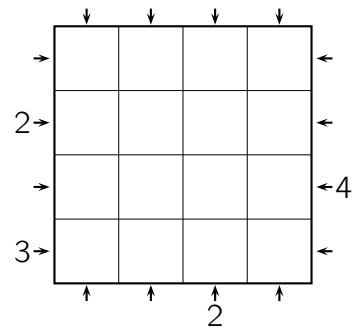

**Gratte-ciel 3**

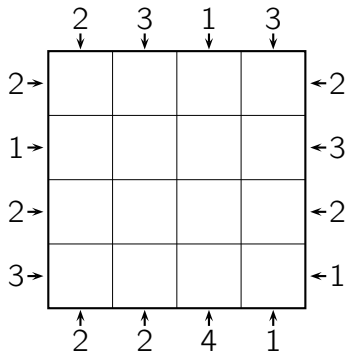

**Gratte-ciel 3 \***

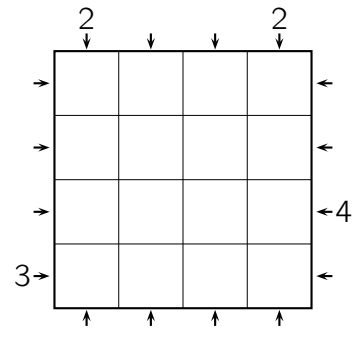

**Gratte-ciel 4**

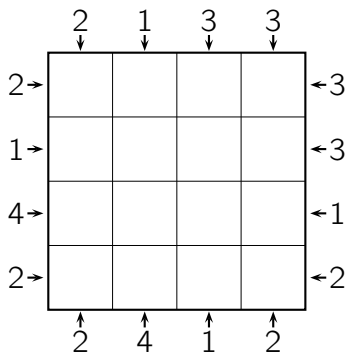

**Gratte-ciel 4 \***

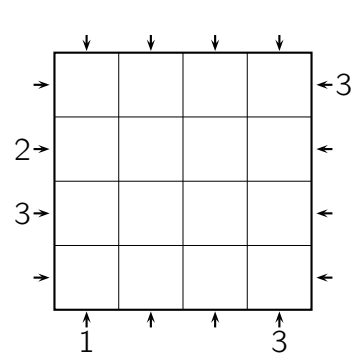

Participant .....

Classe ..... 2024-2025

Participant .....

Classe ..... 2024-2025

**Slants 1**

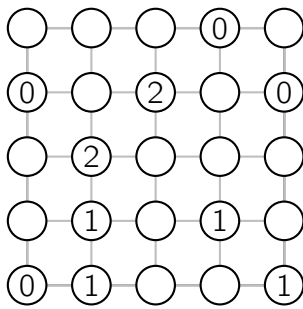

**Slants 1 \***

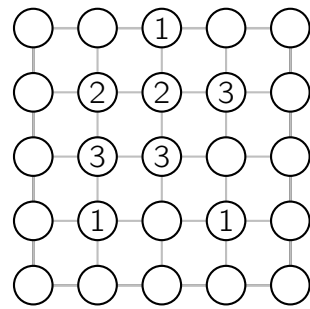

**Slants 2**

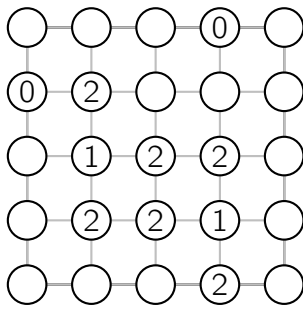

**Slants 2 \***

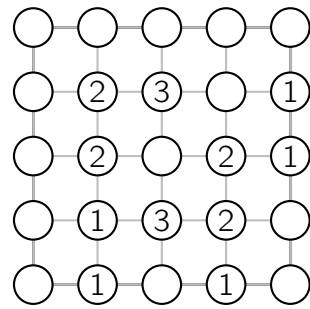

**Slants 3**

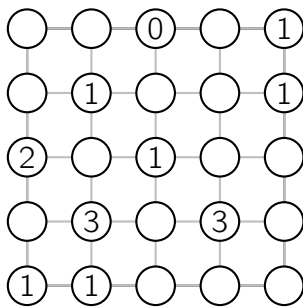

**Slants 3 \***

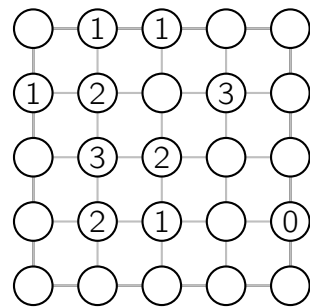

**Slants 4**

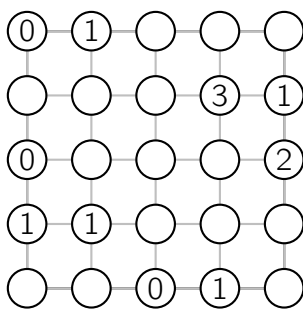

**Slants 4 \***

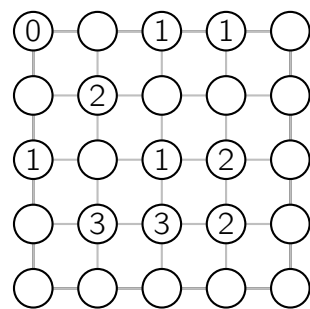

Participant .....

Classe ..... 2024-2025

Participant .....

Classe ..... 2024-2025

### Squaro 1

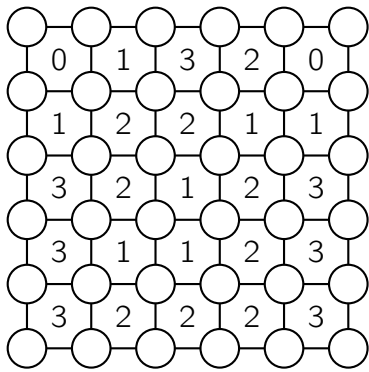

### Squaro 1 \*

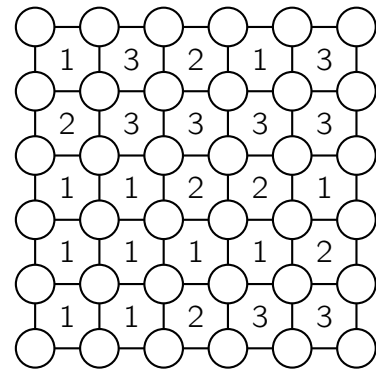

### Squaro 2

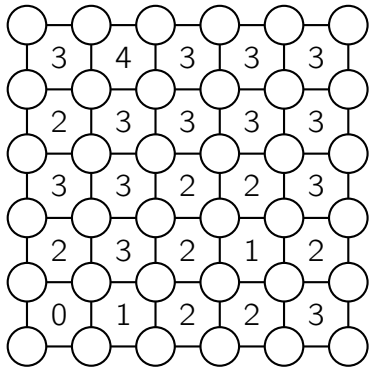

### Squaro 2 \*

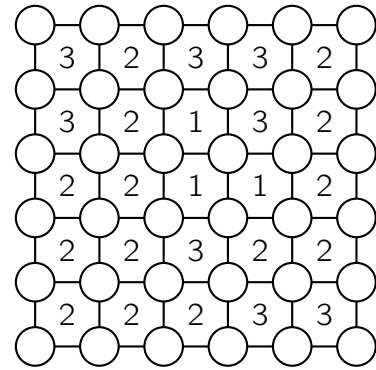

### Squaro 3

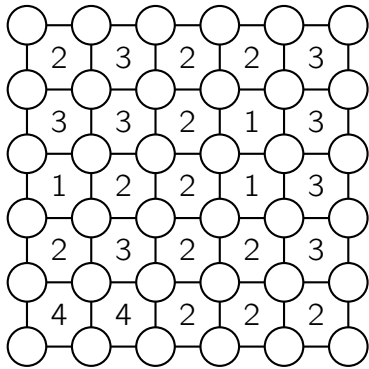

### Squaro 3 \*

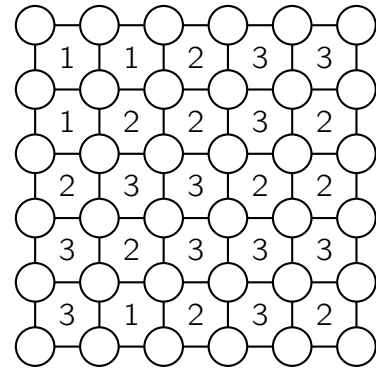

### Squaro 4

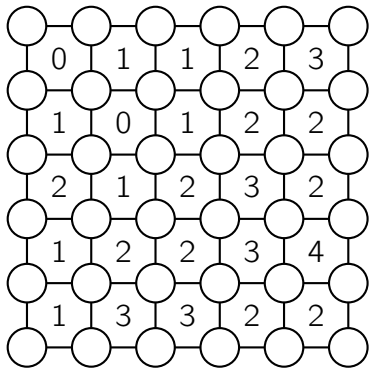

### Squaro 4 \*

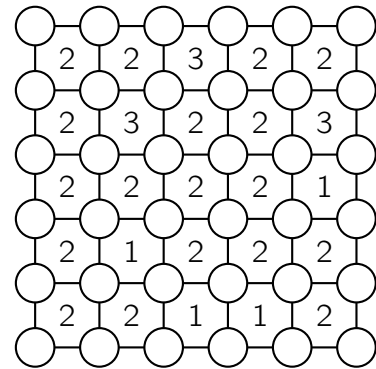

Participant .....

Classe ..... 2024-2025

Participant .....

Classe ..... 2024-2025

### Tentes 1

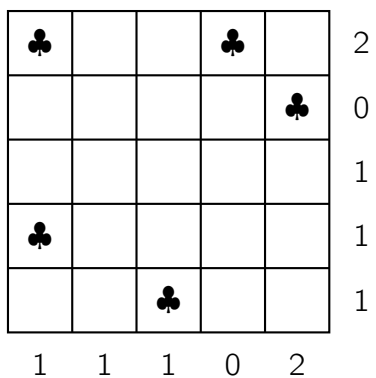

### Tentes 1 \*

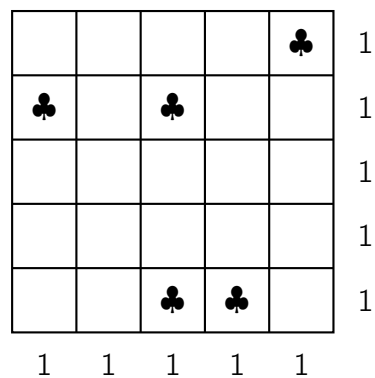

### Tentes 2

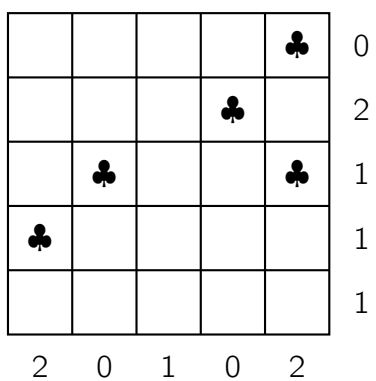

### Tentes 2 \*

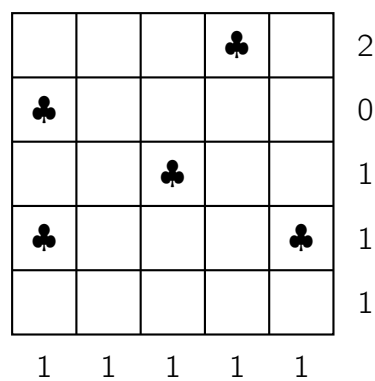

### Tentes 3

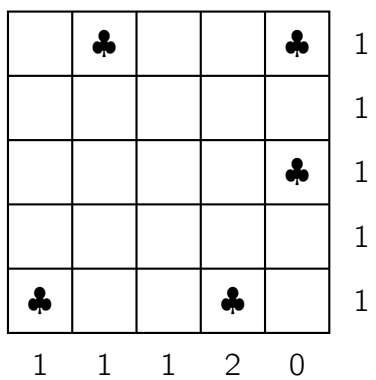

### Tentes 3 \*

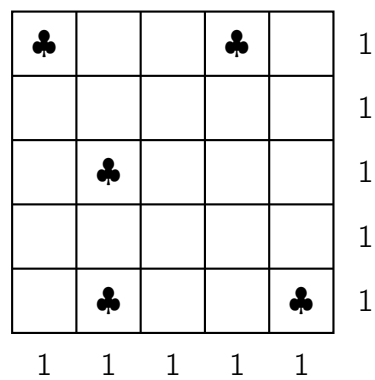

### Tentes 4

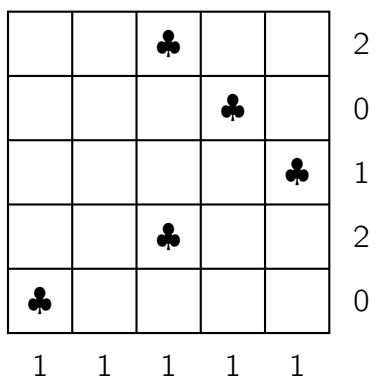

### Tentes 4 \*

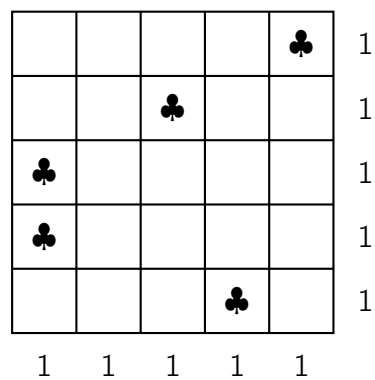

Participant .....

Classe ..... 2024-2025

Participant .....

Classe ..... 2024-2025

**Tracks 1**

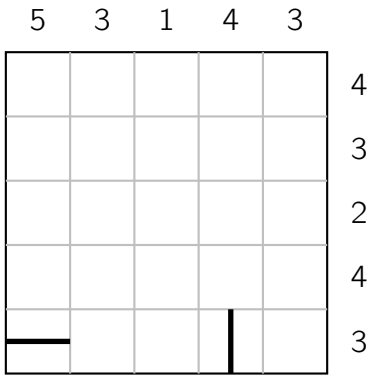

**Tracks 1 \***

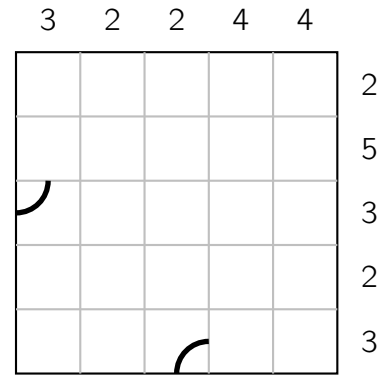

**Tracks 2**

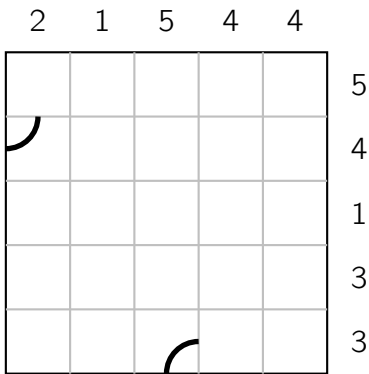

**Tracks 2 \***

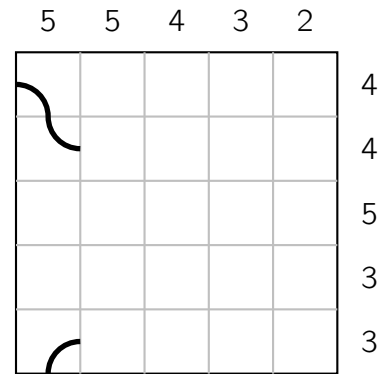

**Tracks 3**

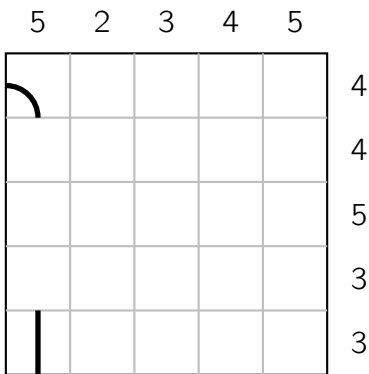

**Tracks 3 \***

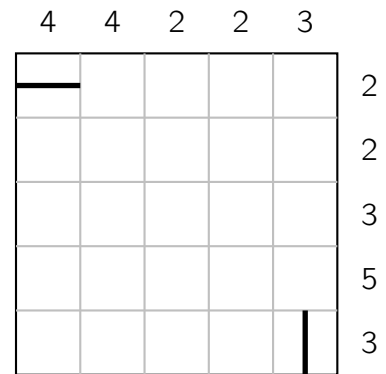

**Tracks 4**

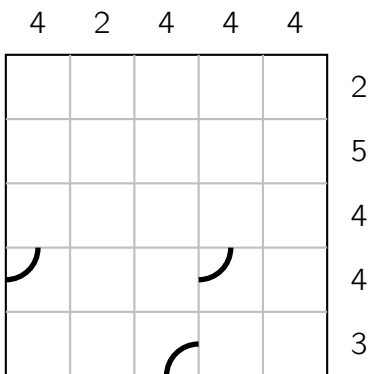

**Tracks 4 \***

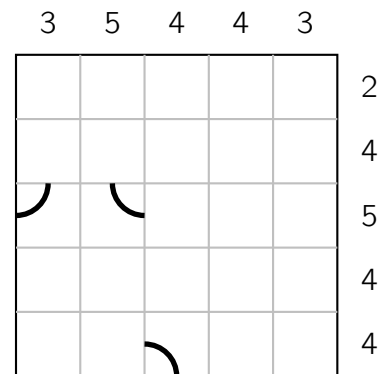

Participant .....

Classe ..... 2024-2025

Participant .....

Classe ..... 2024-2025



**Corrigé 1**

0	1	1	0	0	1
1	1	0	0	1	0
1	0	0	1	1	0
0	0	1	1	0	1
0	1	0	0	1	1
1	0	1	1	0	0

**Corrigé 1 \***

0	0	1	1	0	1
1	1	0	1	0	0
0	0	1	0	1	1
0	1	0	0	1	1
1	0	1	1	0	0
1	1	0	0	1	0

**Corrigé 2**

0	1	0	0	1	1
1	0	1	1	0	0
1	0	1	0	1	0
0	1	0	1	0	1
1	1	0	1	0	0
0	0	1	0	1	1

**Corrigé 2 \***

0	0	1	1	0	1
1	1	0	0	1	0
0	1	0	1	0	1
1	0	1	0	1	0
1	1	0	1	0	0
0	0	1	0	1	1

**Corrigé 3**

1	0	1	1	0	0
0	1	0	0	1	1
1	1	0	1	0	0
1	0	1	0	0	1
0	0	1	0	1	1
0	1	0	1	1	0

**Corrigé 3 \***

1	0	1	0	0	1
0	1	0	1	0	1
0	1	1	0	1	0
1	0	0	1	1	0
0	0	1	1	0	1
1	1	0	0	1	0

**Corrigé 4**

0	1	0	0	1	1
1	0	0	1	1	0
0	1	1	0	0	1
0	1	0	1	1	0
1	0	1	1	0	0
1	0	1	0	0	1

**Corrigé 4 \***

1	0	0	1	1	0
0	1	1	0	0	1
1	0	1	0	1	0
0	1	0	1	1	0
1	0	1	0	0	1
0	1	0	1	0	1

Corrigé 1

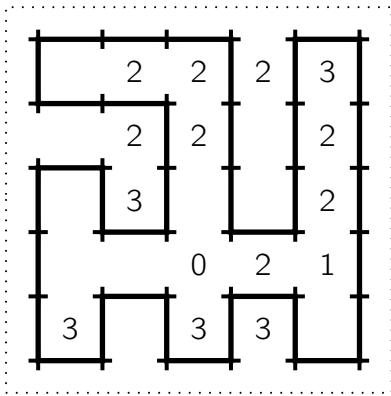

Corrigé 1

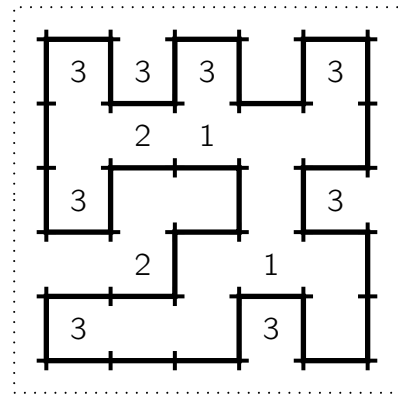

Corrigé 2

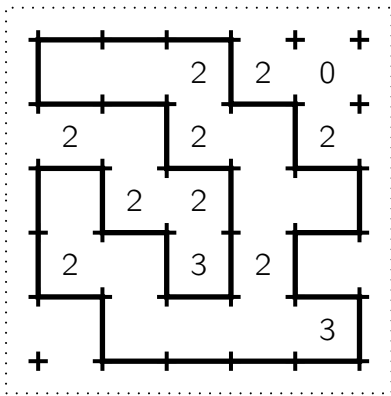

Corrigé 2

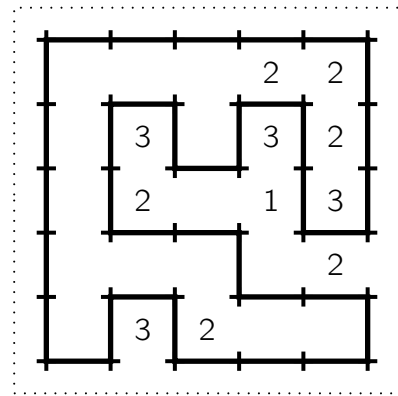

Corrigé 3

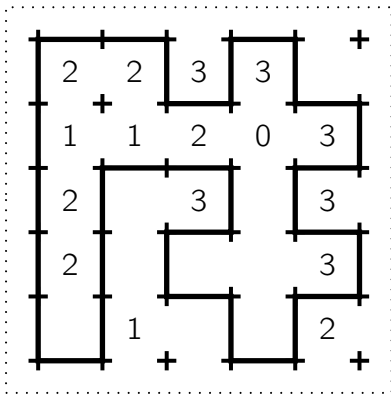

Corrigé 3

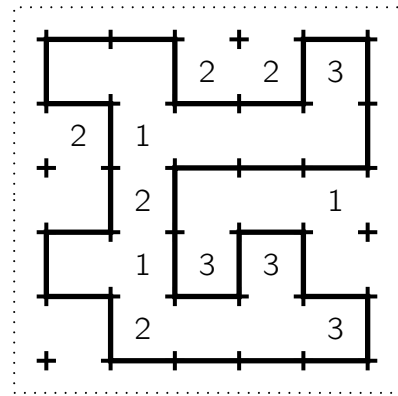

Corrigé 4

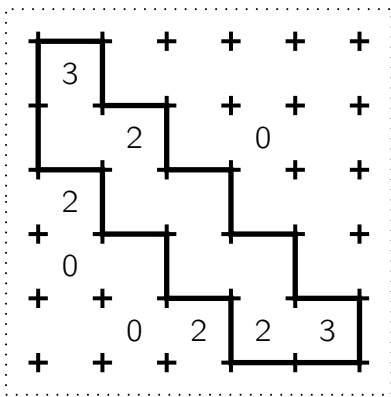

Corrigé 4

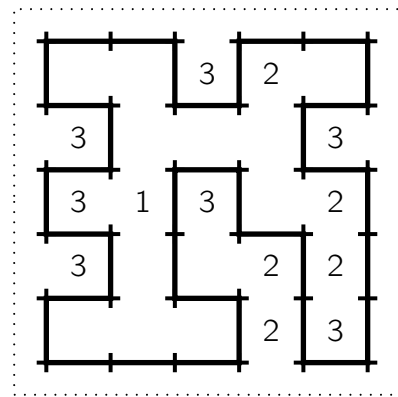

**Corrigé 1**

1	1	0	3	0
3	0	2	1	0
2	2	3	3	1
2	0	1	3	2

0·0	0·1	0·2	0·3	1·1
1·2	1·3	2·2	2·3	3·3

**Corrigé 2**

0	3	0	1	1
0	1	2	0	3
1	3	3	2	2
2	3	1	0	2

0·0	0·1	0·2	0·3	1·1
1·2	1·3	2·2	2·3	3·3

**Corrigé 3**

0	1	3	1	0
2	1	3	2	2
2	3	1	0	1
0	3	3	0	2

0·0	0·1	0·2	0·3	1·1
1·2	1·3	2·2	2·3	3·3

**Corrigé 4**

0	1	2	3	2
0	1	2	1	0
1	0	3	1	2
3	3	2	3	0

0·0	0·1	0·2	0·3	1·1
1·2	1·3	2·2	2·3	3·3

**Corrigé 1 \***

1	1	0	3	0
2	3	1	2	0
2	1	3	3	1
2	0	0	2	3

0·0	0·1	0·2	0·3	1·1
1·2	1·3	2·2	2·3	3·3

**Corrigé 2 \***

0	0	2	1	1
1	1	1	0	0
3	3	0	2	3
2	3	2	2	3

0·0	0·1	0·2	0·3	1·1
1·2	1·3	2·2	2·3	3·3

**Corrigé 3 \***

2	1	3	1	0
3	0	0	2	2
1	1	3	1	3
0	0	3	2	2

0·0	0·1	0·2	0·3	1·1
1·2	1·3	2·2	2·3	3·3

**Corrigé 4 \***

1	1	2	3	3
2	1	1	0	2
2	0	0	3	2
3	1	3	0	0

0·0	0·1	0·2	0·3	1·1
1·2	1·3	2·2	2·3	3·3

### Corrigé 1

	2	3	2	1	
	↓	↓	↓	↓	
2→	3	1	2	4	←1
3→	1	2	4	3	←2
2→	2	4	3	1	←3
1→	4	3	1	2	←3
	↑	↑	↑	↑	

### Corrigé 1 \*

			1		
	↓	↓	↓	↓	
→	3	2	4	1	←
1→	4	1	2	3	←2
→	1	4	3	2	←
3→	2	3	1	4	←
	↑	↑	↑	↑	

### Corrigé 2

	2	3	1	2	
	↓	↓	↓	↓	
2→	2	1	4	3	←2
1→	4	3	1	2	←3
2→	3	4	2	1	←3
4→	1	2	3	4	←1
	↑	↑	↑	↑	

### Corrigé 2 \*

	↓	↓	↓	↓	
→	1	2	4	3	←
2→	3	4	1	2	←
→	4	3	2	1	←4
3→	2	1	3	4	←
	↑	↑	↑	↑	

### Corrigé 3

	2	3	1	3	
	↓	↓	↓	↓	
2→	3	1	4	2	←2
1→	4	2	3	1	←3
2→	1	4	2	3	←2
3→	2	3	1	4	←1
	↑	↑	↑	↑	

### Corrigé 3 \*

	2			2	
	↓	↓	↓	↓	
→	3	4	1	2	←
→	2	1	3	4	←
→	4	3	2	1	←4
3→	1	2	4	3	←
	↑	↑	↑	↑	

### Corrigé 4

	2	1	3	3	
	↓	↓	↓	↓	
2→	3	4	2	1	←3
1→	4	3	1	2	←3
4→	1	2	3	4	←1
2→	2	1	4	3	←2
	↑	↑	↑	↑	

### Corrigé 4 \*

	↓	↓	↓	↓	
→	2	4	3	1	←3
2→	3	1	2	4	←
3→	1	2	4	3	←
→	4	3	1	2	←
	↑	↑	↑	↑	

Corrigé 1

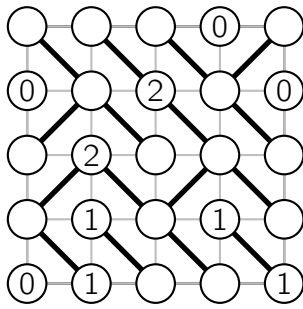

Corrigé 1 \*

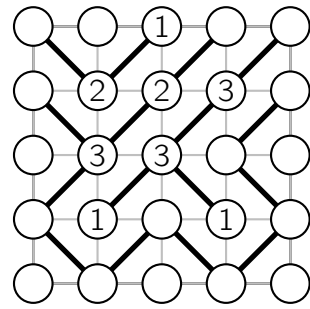

Corrigé 2

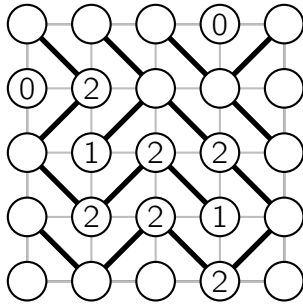

Corrigé 2 \*

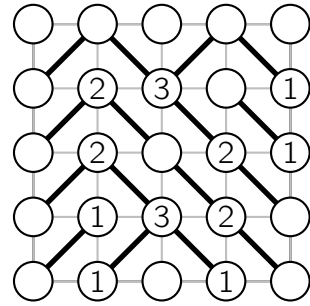

Corrigé 3

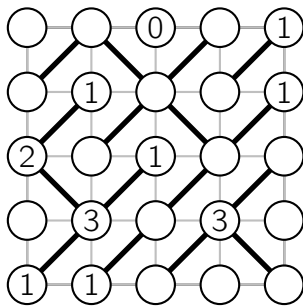

Corrigé 3 \*

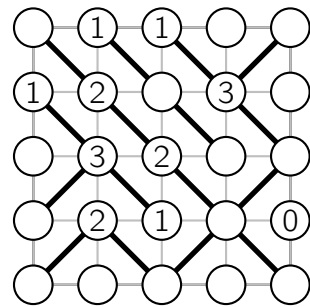

Corrigé 4

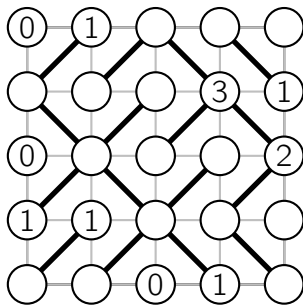

Corrigé 4 \*

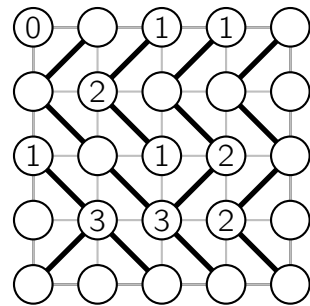

Corrigé 1

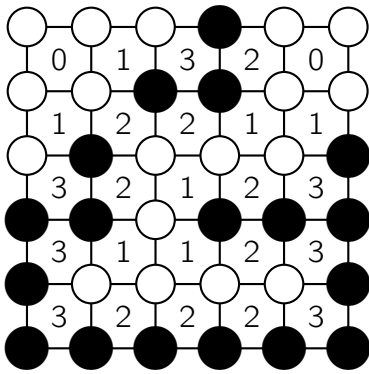

Corrigé 1 \*

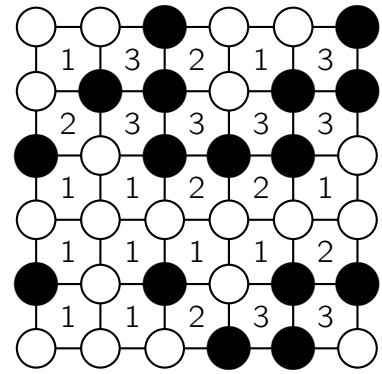

Corrigé 2

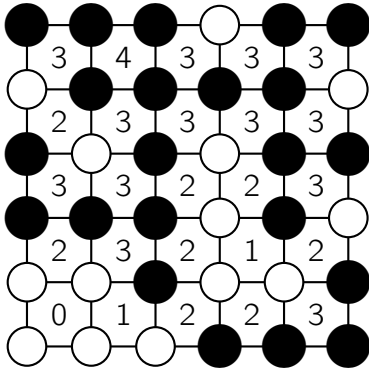

Corrigé 2 \*

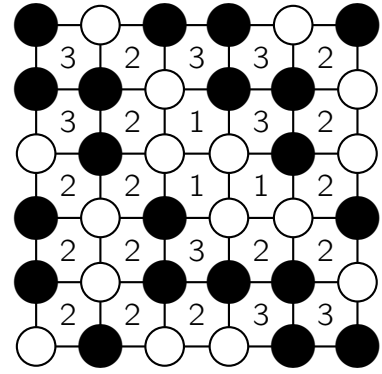

Corrigé 3

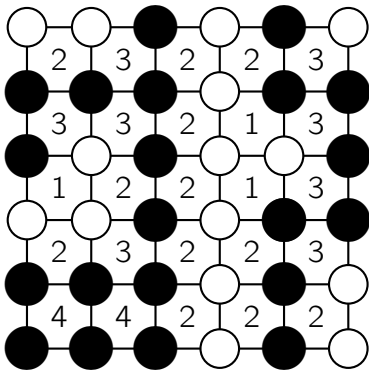

Corrigé 3 \*

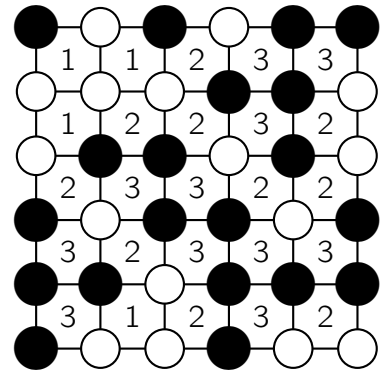

Corrigé 4

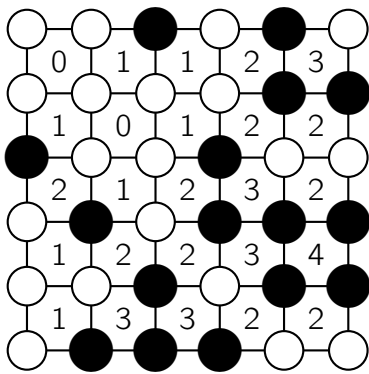

Corrigé 4 \*

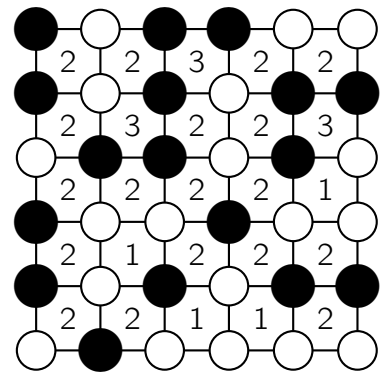

Corrigé 1

♣	△		♣	△	2
				♣	0
				△	1
♣		△			1
△		♣			1
1	1	1	0	2	

Corrigé 1 \*

		△		♣	1
♣		♣		△	1
△					1
			△		1
	△	♣	♣		1
1	1	1	1	1	

Corrigé 2

				♣	0
		△	♣	△	2
△	♣			♣	1
♣				△	1
△					1
2	0	1	0	2	

Corrigé 2 \*

△		△	♣		2
♣					0
		♣	△		1
♣	△			♣	1
				△	1
1	1	1	1	1	

Corrigé 3

	♣		△	♣	1
	△				1
			△	♣	1
△					1
♣		△	♣		1
1	1	1	2	0	

Corrigé 3 \*

♣	△		♣		1
			△		1
△	♣				1
				△	1
	♣	△		♣	1
1	1	1	1	1	

Corrigé 4

	△	♣	△		2
			♣		0
		△		♣	1
△		♣		△	2
♣					0
1	1	1	1	1	

Corrigé 4 \*

		△		♣	1
		♣		△	1
♣	△				1
♣			△		1
△			♣		1
1	1	1	1	1	

Corrigé 1

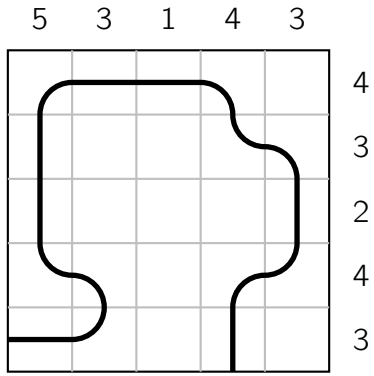

Corrigé 1 \*

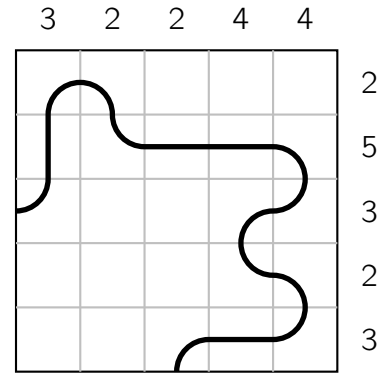

Corrigé 2

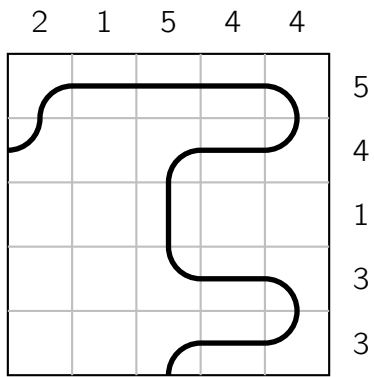

Corrigé 2 \*

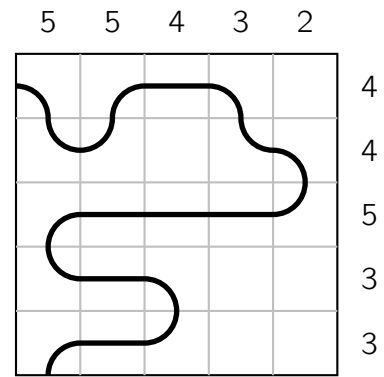

Corrigé 3

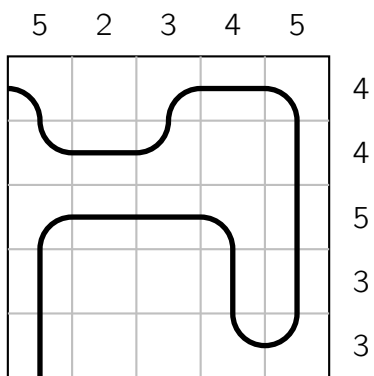

Corrigé 3 \*

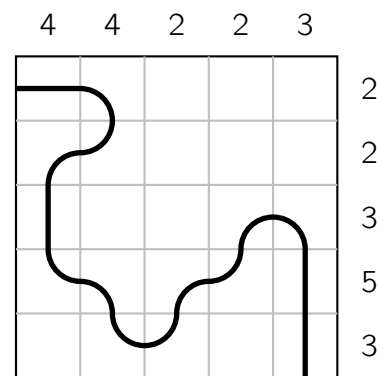

Corrigé 4

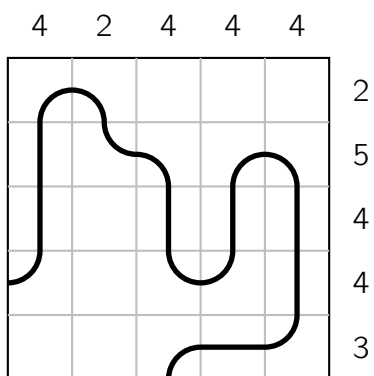

Corrigé 4 \*

